

# Dell Pro Max Micro

FCM2250

Owner's Manual

## Notes, cautions, and warnings

 **NOTE:** A NOTE indicates important information that helps you make better use of your product.

 **CAUTION:** A CAUTION indicates either potential damage to hardware or loss of data and tells you how to avoid the problem.

 **WARNING:** A WARNING indicates a potential for property damage, personal injury, or death.



<b>Chapter 1: Views of Dell Pro Max Micro FCM2250.....</b>	<b>7</b>
Front.....	7
Back.....	8
<b>Chapter 2: Set up your computer.....</b>	<b>10</b>
<b>Chapter 3: Specifications of Dell Pro Max Micro FCM2250.....</b>	<b>15</b>
Dimensions and weight.....	15
Processor.....	15
Chipset.....	16
Operating system.....	16
Memory.....	16
Memory matrix.....	17
External ports and slots.....	18
Internal slots.....	18
Ethernet.....	19
Wireless module.....	19
Audio.....	20
Storage.....	20
Redundant Array of Independent Disks (RAID).....	21
Power adapter.....	21
GPU—Integrated.....	22
Multiple display support matrix.....	22
GPU—Discrete.....	22
Video port resolution.....	23
Hardware security.....	24
Environmental.....	24
Regulatory compliance.....	25
Operating and storage environment.....	25
Dell support policy.....	25
Dell Optimizer.....	25
<b>Chapter 4: Working inside your computer.....</b>	<b>27</b>
Safety instructions.....	27
Before working inside your computer.....	27
Safety precautions.....	28
Electrostatic discharge—ESD protection.....	28
ESD Field Service kit .....	29
Transporting sensitive components.....	30
After working inside your computer.....	30
BitLocker.....	30
Recommended tools.....	30
Screw list.....	31
Major components of Dell Pro Max Micro FCM2250.....	32

<b>Chapter 5: Removing and installing side cover.....</b>	<b>35</b>
Removing the side cover.....	35
Installing the side cover.....	36
<b>Chapter 6: Removing and installing coin-cell battery.....</b>	<b>39</b>
Removing the coin-cell battery.....	39
Installing the coin-cell battery.....	40
<b>Chapter 7: Removing and installing Customer Replaceable Units (CRUs).....</b>	<b>42</b>
Riser-card module.....	42
Removing the riser-card module.....	42
Installing the riser-card module.....	43
Graphics card.....	45
Removing the graphics card .....	45
Installing the graphics card.....	46
System fan.....	49
Removing the system fan.....	49
Installing the system fan.....	49
Memory module.....	50
Removing the memory modules.....	50
Installing the memory modules.....	51
Solid-state drive.....	53
Removing the M.2 2230 SSD (slot-one).....	53
Installing the M.2 2230 SSD (slot-one).....	54
Removing the M.2 2280 SSD (slot-one).....	56
Installing the M.2 2280 SSD (slot-one).....	57
Replacing the M.2 2230 SSD with an M.2 2280 SSD.....	59
Replacing the M.2 2280 SSD with an M.2 2230 SSD.....	60
WLAN card.....	62
Removing the wireless card.....	62
Installing the wireless card.....	63
Speaker.....	65
Removing the speaker.....	65
Installing the speaker.....	66
Speaker holder.....	67
Removing the speaker holder.....	67
Installing the speaker holder.....	67
Optional modules.....	68
Installing the 5G optical fiber port.....	68
Removing the 5G optical fiber port.....	70
Installing the PS2 port.....	71
Removing the PS2 port.....	73
Installing the DisplayPort.....	74
Removing the DisplayPort.....	76
Installing the Thunderbolt port.....	77
Removing the Thunderbolt port.....	79
Installing the HDMI port.....	80
Removing the HDMI port.....	82

<b>Chapter 8: Removing and installing Field Replaceable Units (FRUs)</b> .....	<b>84</b>
Heat sink.....	84
Removing the heat sink.....	84
Installing the heat sink.....	85
Processor.....	86
Removing the processor.....	86
Installing the processor.....	87
System board.....	88
Removing the system board.....	88
Installing the system board.....	92
Power button.....	96
Removing the power button.....	96
Installing the power button.....	97
Internal antenna.....	99
Removing the internal antenna—location one.....	99
Installing the internal antenna—location one.....	99
Removing the internal antenna—location two.....	100
Installing the internal antenna—location two.....	101
 <b>Chapter 9: Software</b> .....	 <b>103</b>
Operating system.....	103
Drivers and downloads.....	103
 <b>Chapter 10: BIOS Setup</b> .....	 <b>104</b>
Entering BIOS Setup program.....	104
Navigation keys.....	104
F12 One Time Boot menu.....	104
BIOS Setup options.....	105
Updating the BIOS.....	114
Updating the BIOS in Windows.....	114
Updating the BIOS in Linux and Ubuntu.....	115
Updating the BIOS using the USB drive in Windows.....	115
Updating the BIOS from the One-Time boot menu.....	115
System and setup password.....	115
Assigning a System Setup password.....	116
Deleting or changing an existing system password or setup password.....	116
Clearing CMOS settings.....	117
Clearing system and setup passwords.....	117
 <b>Chapter 11: Troubleshooting</b> .....	 <b>118</b>
Dell SupportAssist Pre-boot System Performance Check diagnostics.....	118
Running the SupportAssist Pre-Boot System Performance Check.....	118
Power-Supply Unit Built-in Self-Test .....	118
System-diagnostic lights.....	118
Recovering the operating system.....	119
Real-Time Clock—RTC reset.....	120
Backup media and recovery options.....	120
Network power cycle.....	120

<b>Chapter 12: Getting help and contacting Dell.....</b>	<b>121</b>
<b>Chapter 13: Revision history.....</b>	<b>122</b>

# Views of Dell Pro Max Micro FCM2250

## Front

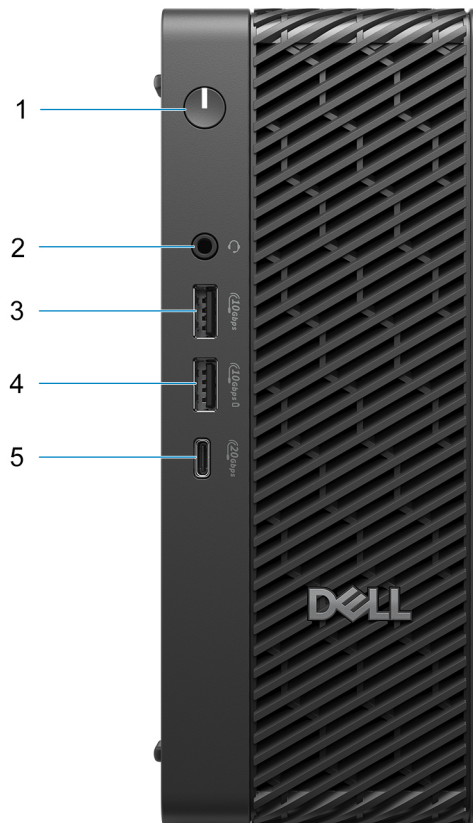

Figure 1. Front view

**1. Power button with diagnostic LED**

Press to turn on the computer if it is turned off, in sleep state, or in hibernate state.

**2. Headset port**

Connect headphones or a headset (headphone and microphone combo).

**3. USB 3.2 Gen 2 port**

Connect devices such as external storage devices and printers. Provides data transfer speeds up to 10 Gbps.

**4. USB 3.2 Gen 2 port with PowerShare**

Connect devices such as external storage devices and printers.

Provides data transfer speeds up to 10 Gbps. PowerShare enables you to charge connected USB devices.

**NOTE:** Connected USB devices will not charge when the computer is turned off or in a sleep state. To start charging connected devices, turn on the computer.

## 5. USB 3.2 Gen 2x2 Type-C port

Connect devices such as external storage devices and printers. Provides data transfer rate of up to 20 Gbps.

# Back

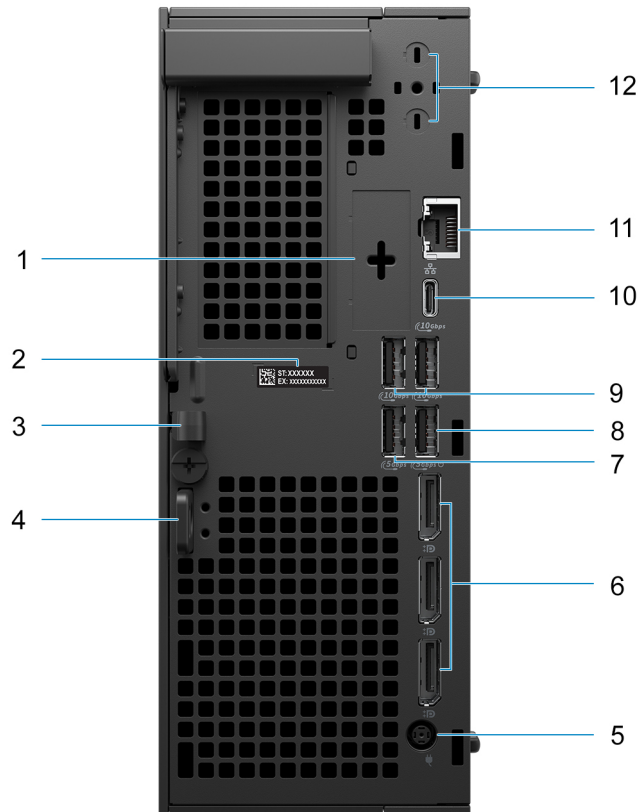

**Figure 2. Back view**

## 1. Optional module

**NOTE:** Optional module port, which can be configured with one of the following options:

- One VGA port
- One HDMI 2.1 FRL port
- One DisplayPort 2.1 (UHBR20)
- One Serial port
- One PS2 port
- One USB Type-C with DisplayPort Alt Mode
- Two USB Type-A ports
- One Thunderbolt 4 port and one USB Type-C port
- One 5G Optical Fiber port
- One 5GbE LAN NIC port

## 2. **Service Tag**

The Service Tag is a unique alphanumeric identifier that enables Dell service technicians to identify the hardware components in your computer and access warranty information.

## 3. **Power-cable clip**

For power-adapter cable routing.

## 4. **Security-cable slot**

Connect a security cable to prevent unauthorized movement of your computer.

## 5. **Power port**

Connect a power cable to provide power to your computer.

## 6. **Three DisplayPort 1.4a (HBR3) ports**

Connect an external display or a projector.

## 7. **USB 3.2 Gen 1 (5 Gbps) port**

Connect devices such as external storage devices and printers. Provides data transfer speeds up to 5 Gbps.

## 8. **USB 3.2 Gen 1 (5 Gbps) with Smart Power On port**

Connect devices such as external storage devices and printers. Provides data transfer speeds up to 5 Gbps.

## 9. **Two USB 3.2 Gen 2 (10 Gbps) ports**

Connect devices such as external storage devices and printers. Provides data transfer speeds up to 10 Gbps.

## 10. **USB 3.2 Gen 2 (10 Gbps) Type-C port**

Connect devices such as external storage devices and printers.

Provides data transfer speeds up to 10 Gbps. PowerShare enables you to charge connected USB devices.



**NOTE:** Connected USB devices will not charge when the computer is turned off or in a sleep state. Turn on the computer to charge the connected USB devices.

## 11. **RJ45 ethernet port (1 Gbps)**

Connect an RJ45 ethernet cable from a router or a broadband modem for network or Internet access, with a transfer rate of 10/100/1000 Mbps (maximum 1 Gbps).

## 12. **External antenna connector ports**

Ports for an optional external antenna.

## Set up your computer

### Steps

1. Connect the wired keyboard and mouse to the available ports. To connect a wireless keyboard and mouse, see the instructions on how to connect in the documentation that ships with the wireless keyboard and mouse.

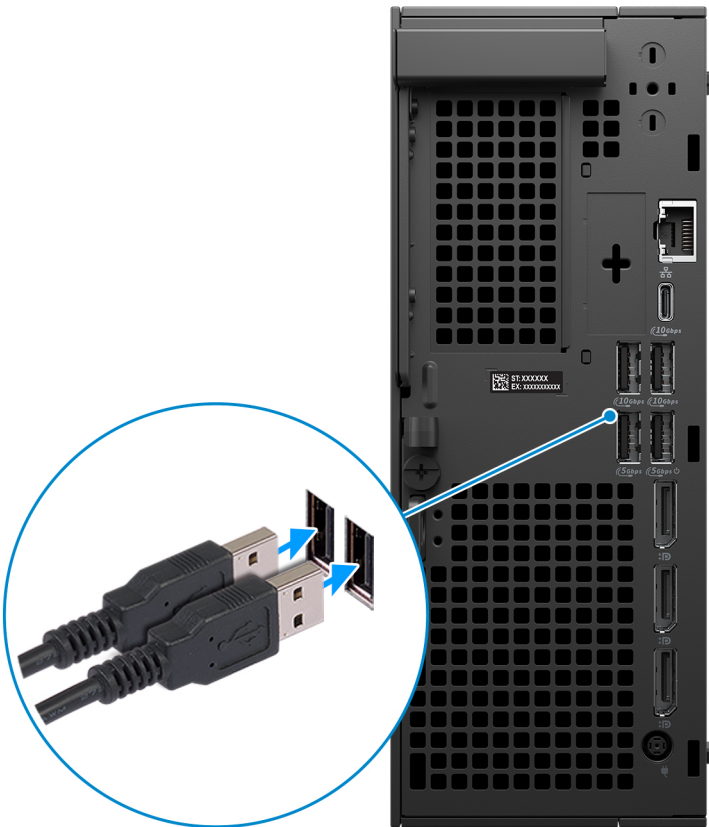

2. Connect to your network using a cable, or connect to a wireless network.



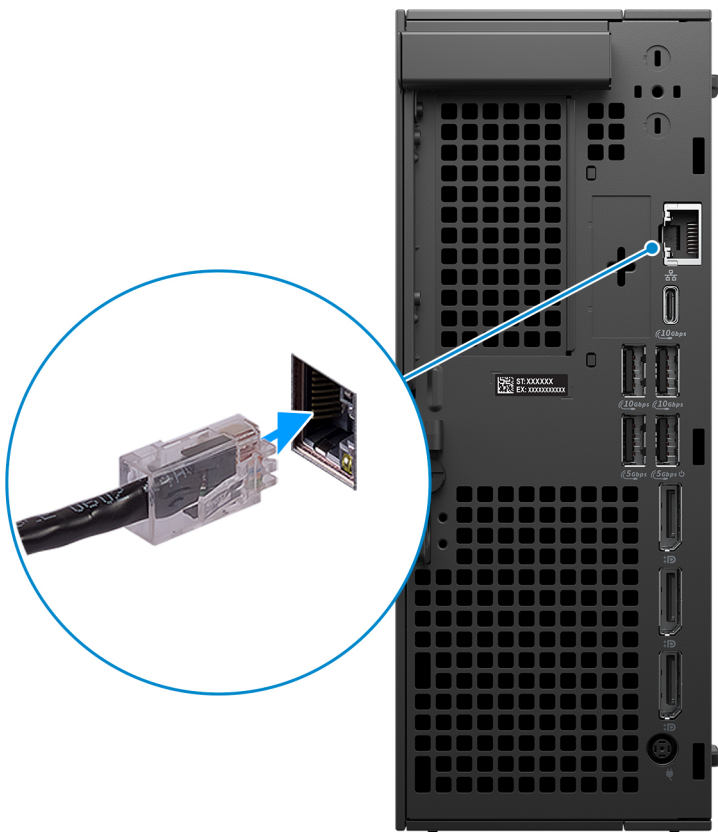

3. Connect the display. For more information about setting up the display, see the documentation that is shipped with your display.

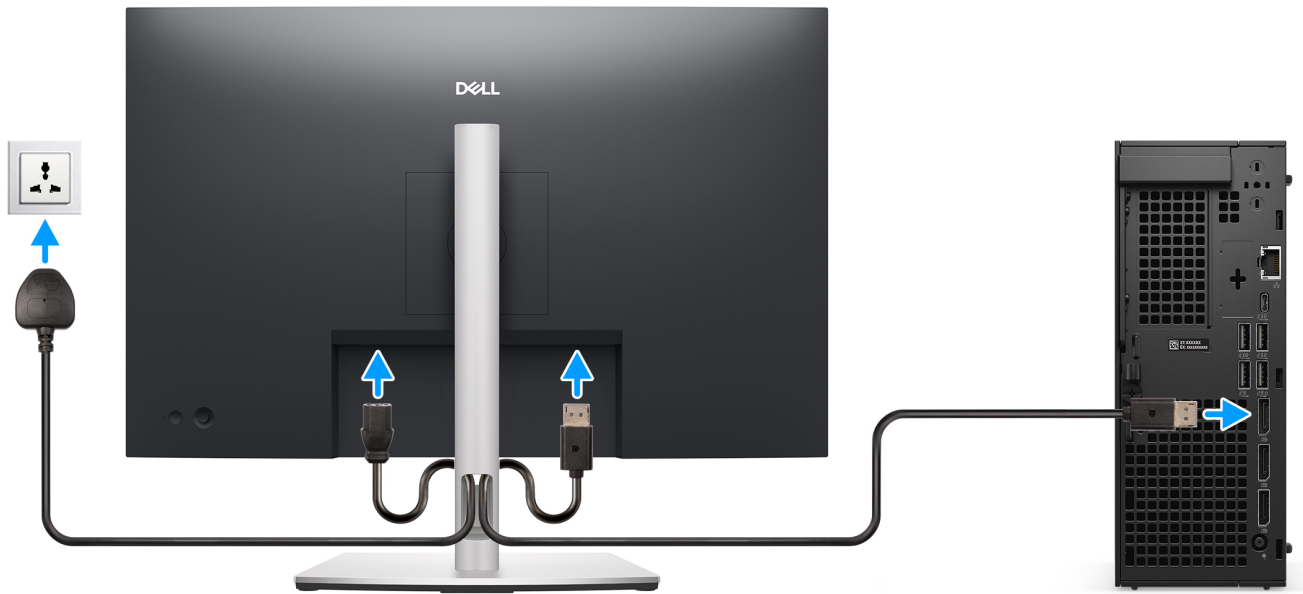

4. Connect the power cable to the computer and then connect it to the wall outlet.

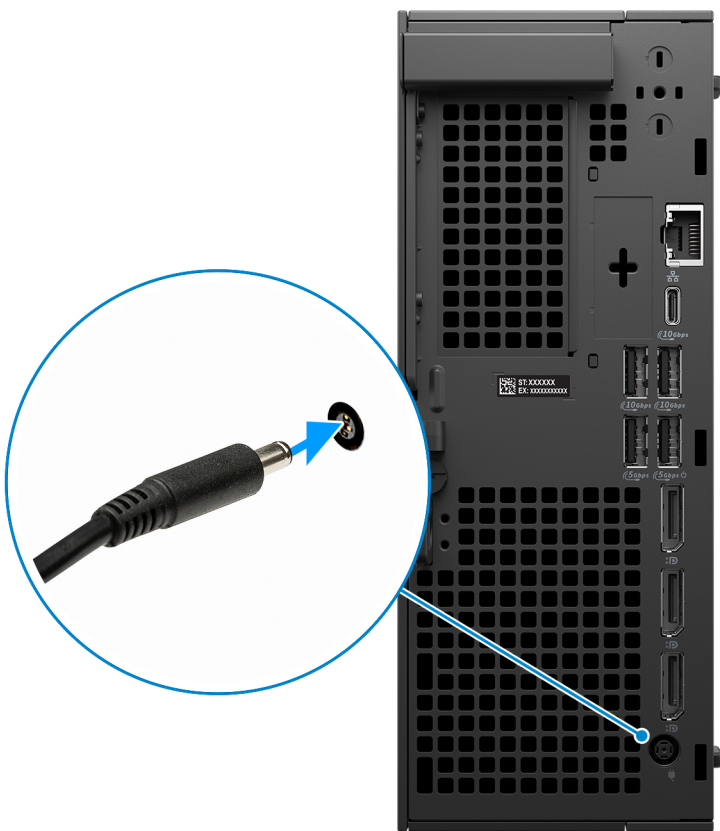

5. Press the power button at the front of the computer to turn on the computer.



6. Finish the operating system setup.

**For Ubuntu:**

Follow the on-screen instructions to complete the setup. For more information about installing and configuring Ubuntu, search in the Knowledge Base Resource at [Dell Support Site](#).

**For Windows:**

Follow the on-screen instructions to complete the setup. When setting up, Dell Technologies recommends that you:

- Connect to a network for Windows updates.

**NOTE:** If connecting to a secured wireless network, enter the password for the wireless network access when prompted.



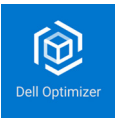

- If connected to the Internet, sign-in with or create a Microsoft account. If not connected to the Internet, create an offline account.
- On the **Support and Protection** screen, enter your contact details.

7. Locate and use Dell apps from the Windows Start menu—Recommended.

**Table 1. Locate Dell apps**

Resources	Description
	<p>Dell Optimizer is an application is designed to enhance computer performance and productivity by optimizing settings for power, battery, display, collaboration touchpad, and presence detection. It also provides access to applications purchased with your new computer.</p> <p>For more information, see Dell Optimizer User's Guide at <a href="#">Dell Support Site</a></p>

**Table 1. Locate Dell apps (continued)**

Resources	Description
	<p><b>Dell Product Registration</b> Register your computer with Dell.</p>
	<p><b>Dell Help &amp; Support</b> Access help and support for your computer.</p>
	<p><b>SupportAssist</b></p> <p>SupportAssist is a proactive and predictive technology that offers automated technical support for Dell computers. It proactively monitors both hardware and software, addressing performance issues, preventing security threats, and automating engagement with Dell Technical Support.</p> <p>. For more information, see Support Assist documentation at <a href="#">Dell Support Site</a>.</p> <p> <b>NOTE:</b> In SupportAssist, click the warranty expiry date to renew or upgrade your warranty.</p>

# Specifications of Dell Pro Max Micro FCM2250

## Dimensions and weight

The following table lists the height, width, depth, and weight of your Dell Pro Max Micro FCM2250.

**Table 2. Dimensions and weight**

Description	Values
Height	206.00 mm (8.11 in.)
Width	79.30 mm (3.12 in.)
Depth	178 mm (7.00 in.)
Weight  <b>NOTE:</b> The weight of your computer depends on the configuration that is ordered and manufacturing variability.	<ul style="list-style-type: none"> <li>• Maximum: 2.54 kg (5.59 lb)</li> <li>• Minimum: 1.89 kg (4.16 lb)</li> </ul>

## Processor

The following table lists the details of the processors that are supported on your Dell Pro Max Micro FCM2250.

**Table 3. Processor**

Description	Option one	Option two	Option three	Option four
Type	Intel Core Ultra 9 285 vPro	Intel Core Ultra 7 265 vPro	Intel Core Ultra 5 245 vPro	Intel Core Ultra 5 235 vPro
Wattage	65 W	65 W	65 W	65 W
Core count	24	20	14	14
Thread count	24	20	14	14
Speed	2.50 GHz to 5.60 GHz	2.40 GHz to 5.30 GHz	3.50 GHz to 5.10 GHz	3.40 GHz to 5 GHz
Cache	36 MB	30 MB	24 MB	24 MB
Integrated graphics	Intel Graphics	Intel Graphics	Intel Graphics	Intel Graphics

# Chipset

The following table lists the details of the chipset supported by your Dell Pro Max Micro FCM2250.

**Table 4. Chipset**

Description	Values
Chipset	W880
Processor	Intel Core Ultra 9/7/5 vPro processors
DRAM bus width	64-bit
Flash EPROM	32 MB + 32 MB
PCIe bus	Up to Gen4
Non-volatile memory	Yes
BIOS configuration Serial Peripheral Interface (SPI)	256 Mbit (32 MB) located at SPI_FLASH
Trusted Platform Module (TPM) 2.0 (Discrete TPM Enabled)	24 KB located at TPM 2.0 on chipset
Firmware-TPM (Discrete TPM disabled)	By default the Platform Trust Technology feature is visible to the operating system.
NIC EEPROM	LOM configuration contained within SPI flash ROM instead of LOM e-fuse

# Operating system

Your Dell Pro Max Micro FCM2250 supports the following operating systems:

- Windows 11 Home, 64-bit
- Windows 11 Pro, 64-bit
- Windows 11 Pro National Education, 64-bit
- Windows 11 Pro for Workstations
- Ubuntu Linux 24.04 LTS, 64-bit

# Memory

The following table lists the memory specifications that are supported by your Dell Pro Max Micro FCM2250.

**Table 5. Memory specifications**

Description	Values
Memory slots	Two-SODIMM slots
Memory type	DDR5
Memory speed	<ul style="list-style-type: none"><li>• 5600 MT/s</li><li>• 6400 MT/s</li></ul>
Maximum memory configuration	64 GB
Minimum memory configuration	8 GB

**Table 5. Memory specifications (continued)**

Description	Values
Memory size per slot	8 GB, 16 GB, 32 GB
Memory configurations supported	<ul style="list-style-type: none"> <li>● 8 GB: 1 x 8 GB, DDR5, 5600 MT/s, Non-ECC, single-channel</li> <li>● 16 GB: 1 x 16 GB, DDR5, 5600 MT/s, Non-ECC, single-channel</li> <li>● 16 GB: 2 x 8 GB, DDR5, 5600 MT/s, Non-ECC, dual-channel</li> <li>● 32 GB: 1 x 32 GB, DDR5, 5600 MT/s, Non-ECC, single-channel</li> <li>● 32 GB: 2 x 16 GB, DDR5, 5600 MT/s, Non-ECC, dual-channel</li> <li>● 64 GB: 2 x 32 GB, DDR5, 5600 MT/s, Non-ECC, dual-channel</li> <li>● 16 GB: 1 x 16 GB, DDR5, 5600 MT/s, ECC, single-channel</li> <li>● 16 GB: 2 x 8 GB, DDR5, 5600 MT/s, ECC, dual-channel</li> <li>● 32 GB: 1 x 32 GB, DDR5, 5600 MT/s, ECC, single-channel</li> <li>● 32 GB: 2 x 16 GB, DDR5, 5600 MT/s, ECC, dual-channel</li> <li>● 64 GB: 2 x 32 GB, DDR5, 5600 MT/s, ECC, dual-channel</li> <li>● 8 GB: 1 x 8 GB, DDR5, 6400 MT/s, Non-ECC, single-channel</li> <li>● 16 GB: 1 x 16 GB, DDR5, 6400 MT/s, Non-ECC, single-channel</li> <li>● 16 GB: 2 x 8 GB, DDR5, 6400 MT/s, Non-ECC, dual-channel</li> <li>● 32 GB: 1 x 32 GB, DDR5, 6400 MT/s, Non-ECC, single-channel</li> <li>● 32 GB: 2 x 16 GB, DDR5, 6400 MT/s, Non-ECC, dual-channel</li> <li>● 64 GB: 2 x 32 GB, DDR5, 6400 MT/s, Non-ECC, dual-channel</li> </ul>

## Memory matrix

The following table lists the memory configurations supported on your Dell Pro Max Micro FCM2250.

**Table 6. Memory matrix**

Configuration	Memory matrix for Non-ECC		Memory matrix for ECC	
	SODIMM1	SODIMM2	SODIMM1	SODIMM2
8 GB DDR5	8 GB	N/A	8 GB	N/A
16 GB DDR5	8 GB	8 GB	8 GB	8 GB
16 GB DDR5	16 GB	N/A	16 GB	N/A
32 GB DDR5	16 GB	16 GB	16 GB	16 GB
32 GB DDR5	32 GB	N/A	32 GB	N/A
64 GB DDR5	32 GB	32 GB	32 GB	32 GB

## External ports and slots

The following table lists the external ports and slots of your Dell Pro Max Micro FCM2250.

**Table 7. External ports and slots**

Description	Values
Network port	One RJ45 ethernet port (1 Gbps)
USB ports	Front: <ul style="list-style-type: none"> <li>• One USB 3.2 Gen 2x2 (20 Gbps) Type-C port</li> <li>• One USB 3.2 Gen 2 (10 Gbps) with PowerShare port</li> <li>• One USB 3.2 Gen 2 (10 Gbps) port</li> </ul> Rear: <ul style="list-style-type: none"> <li>• One USB 3.2 Gen 2 (10 Gbps) Type-C port</li> <li>• Two USB 3.2 Gen 2 (10 Gbps) ports</li> <li>• One USB 3.2 Gen 1 (5 Gbps) with Smart Power On port</li> <li>• One USB 3.2 Gen 1 (5 Gbps) ports</li> <li>• One serial port (optional)</li> <li>• One serial and PS2 port using fan out cable (optional)</li> </ul>
Audio port	One headset (headphone and microphone combo) port
Video port(s)	Three DisplayPort 1.4a (HBR3 support) ports
Power-adaptor port	<ul style="list-style-type: none"> <li>• 280 W AC adapter, 7.40 mm barrel</li> <li>• 180 W AC adapter, 7.40 mm barrel</li> </ul>
Security-cable slot	<ul style="list-style-type: none"> <li>• One Kensington lock slot</li> <li>• One padlock ring</li> </ul>
Optional port	One optional module port which can be configured with one of the following options: <ul style="list-style-type: none"> <li>• One VGA port</li> <li>• One HDMI 2.1 FRL port</li> <li>• One DisplayPort 2.1 (UHBR20)</li> <li>• One Serial/PS2 port</li> <li>• One USB Type C with DisplayPort Alt Mode</li> <li>• Two USB Type-A ports</li> <li>• One Thunderbolt 4 port + One USB Type-C port</li> <li>• One 5G Optical Fiber port</li> <li>• One 5GbE LAN NIC port</li> </ul>

## Internal slots

The following table lists the internal slots of your Dell Pro Max Micro FCM2250.

**Table 8. Internal slots**

Description	Values
Expansion slots	Two half-height Gen4 PCIe x8 slots (x8 and x1 electrically)
M.2	<ul style="list-style-type: none"> <li>• One M.2 2230 slot for Wi-Fi and Bluetooth combo card</li> <li>• One M.2 2280 Gen4 PCIe NVMe single-sided SSD</li> </ul>



**Table 8. Internal slots (continued)**

Description	Values
	 <b>NOTE:</b> To learn more about the features of different types of M.2 cards, search in the Knowledge Base Resource at <a href="#">Dell Support Site</a> .

## Ethernet

The following table lists the wired ethernet Local Area Network (LAN) specifications of your Dell Pro Max Micro FCM2250.

**Table 9. Ethernet specifications**

Description	Values
Model	Intel ethernet connection I219-LM
Transfer rate	10/100/1000 Mbps

## Wireless module

The following table lists the Wireless Local Area Network (WLAN) modules that are supported on your Dell Pro Max Micro FCM2250.

**Table 10. Wireless module specifications**

Description	Option one	Option two
Model number	Intel BE200	Qualcomm FastConnect 7800 DBS
Transfer rate	5760 Mbps	5760 Mbps
Frequency bands supported	2.40 GHz/5 GHz/6 GHz	2.40 GHz/5 GHz/6 GHz
Wireless standards	<ul style="list-style-type: none"> <li>● Wi-Fi 802.11a/b/g</li> <li>● Wi-Fi 4 (Wi-Fi 802.11n)</li> <li>● Wi-Fi 5 (Wi-Fi 802.11ac)</li> <li>● Wi-Fi 6E (Wi-Fi 802.11ax)</li> <li>● Wi-Fi 7 (Wi-Fi 802.11be)</li> </ul>	<ul style="list-style-type: none"> <li>● Wi-Fi 802.11a/b/g</li> <li>● Wi-Fi 4 (Wi-Fi 802.11n)</li> <li>● Wi-Fi 5 (Wi-Fi 802.11ac)</li> <li>● Wi-Fi 6E (Wi-Fi 802.11ax)</li> <li>● Wi-Fi 7 (Wi-Fi 802.11be)</li> </ul>
Encryption	<ul style="list-style-type: none"> <li>● 64-bit/128-bit WEP</li> <li>● AES-CCMP</li> <li>● TKIP</li> </ul>	<ul style="list-style-type: none"> <li>● 64-bit/128-bit WEP</li> <li>● AES-CCMP</li> <li>● TKIP</li> </ul>
Bluetooth wireless card  <b>NOTE:</b> The functionality of the Bluetooth wireless card may vary based on the operating system.	Bluetooth 5.4 wireless card	Bluetooth 5.4 wireless card

# Audio

The following table lists the audio specifications of your Dell Pro Max Micro FCM2250.

**Table 11. Audio specifications**

Description	Values
Audio type	4 Channel High Definition Audio
Audio controller	Realtek ALC3204 Codec
Internal audio interface	Intel HDA (high-definition audio)
External audio interface	One headset (headphone and microphone combo) port
Speakers	Waves MaxxAudio 14.0, Internal speakers

# Storage

This section lists the storage options on your Dell Pro Max Micro FCM2250.

**Table 12. Storage matrix**

Storage type	M.2 PCIe SSD-0	M.2 PCIe SSD-1	RAID support
M.2 Solid-State Drive (Boot/Primary)	2230	None	None
M.2 Solid-State Drive (Boot/Primary)	2280	None	None
M.2 Solid-State Drive (Boot/Primary) + M.2 SSD (Secondary)	2230	2230	RAID 0 or RAID 1
M.2 Solid-State Drive (Boot/Primary) + M.2 SSD (Secondary)	2280	2280	RAID 0 or RAID 1 (same capacity only)
M.2 Solid-State Drive (Boot/Primary) + M.2 SSD (Secondary)	2230	2280	None
M.2 Solid-State Drive (Boot/Primary) + M.2 SSD (Secondary)	2230	2280	None

 **NOTE:** For more information about RAID, see [Redundant Array of Independent Disks \(RAID\)](#).

**Table 13. Storage specifications**

Storage type	Interface type	Capacity
M.2 2230 solid-state drive	TLC Gen4 PCIe NVMe	256 GB
M.2 2230 solid-state drive	TLC Gen4 PCIe NVMe	512 GB
M.2 2280 solid-state drive	TLC Gen4 PCIe NVMe, Self-Encrypting Opal 2.0	512 GB
M.2 2280 solid-state drive	TLC Gen4 PCIe NVMe, Self-Encrypting Opal 2.0	1 TB
M.2 2280 solid-state drive	TLC Gen4 PCIe NVMe, Self-Encrypting Opal 2.0	2 TB
M.2 2280 solid-state drive	TLC Gen4 PCIe NVMe, Self-Encrypting Opal 2.0	4 TB

**Table 13. Storage specifications (continued)**

Storage type	Interface type	Capacity
 <b>NOTE:</b> Contact your Independent Software Vendor (ISV) for assistance with enabling multiple SED SSD encryption.		

## Redundant Array of Independent Disks (RAID)

For optimal performance when configuring drives as a RAID volume, Dell Technologies recommends using identical drive models.

RAID 0 (Striped, Performance) volumes benefit from higher performance when drives are matched because the data is split across multiple drives: However, any I/O operations with block sizes larger than the stripe size will be constrained by the slowest drive in the array. For RAID 0 I/O operations where block sizes are smaller than the stripe size, whichever drive the I/O operation targets, determines the performance, which increases variability and results in inconsistent latencies. This variability is particularly pronounced for write operations, and it can be problematic for applications that are latency sensitive. One such example of this is any application that performs thousands of random writes per second in very small block sizes.

RAID 1 (Mirrored, Data Protection) volumes benefit from higher performance when drives are matched because the data is mirrored across multiple drives all I/O operations must be performed identically to both drives, thus variations in drive performance when the models are different result in the I/O operations completing only as fast as the slowest drive. While this does not suffer from the variable latency issue in small random I/O operations as with RAID 0 across heterogeneous drives, the impact is nonetheless large because the higher performing drive becomes limited in all I/O types. One of the worst examples of constrained performance here is when using unbuffered I/O. To ensure that that writes are fully committed to nonvolatile regions of the RAID volume, unbuffered I/O bypasses cache (for example by using the Force Unit Access bit in the NVMe protocol) and the I/O operation will not complete until all the drives in the RAID volume have completed the request to commit the data. This kind of I/O operation completely negates any advantage of a higher performing drive in the volume.

Care must be taken to match not only the drive vendor, capacity, and class, but also the specific model. Drives from the same vendor, with the same capacity, and even within the same class, can have different performance characteristics for certain types of I/O operations. Thus, matching by model ensures that the RAID volume consists of a homogeneous array of drives that deliver all the benefits of a RAID volume without incurring the additional penalties when one or more drives in the volume are lower performing.

RAID support for this model is shown in [Storage matrix](#).

## Power adapter

The following table lists the power adapter specifications of your Dell Pro Max Micro FCM2250.

**Table 14. Power adapter specifications**

Description	Option one	Option two
Type	180 W AC adapter, 7.4mm barrel	280 W AC adapter, 7.4mm barrel
Connector dimensions:		
External diameter	7.40 mm (0.29 in.)	7.40 mm (0.29 in.)
Internal diameter	5.10 mm (0.20 in.)	5.10 mm (0.20 in.)
Input voltage	100 VAC x 240 VAC	100 VAC x 240 VAC
Input frequency	50 Hz x 60 Hz	50 Hz x 60 Hz
Input current (maximum)	2.34 A	4 A
Output current (continuous)	9.23 A	14.36 A
Rated output voltage	19.50 VDC	19.50 VDC
Temperature range:		

**Table 14. Power adapter specifications (continued)**

Description		Option one	Option two
	Operating	0°C to 40°C (32°F to 104°F)	0°C to 40°C (32°F to 104°F)
	Storage	-40°C to 70°C (-40°F to 158°F)	-40°C to 70°C (-40°F to 158°F)

**CAUTION:** Operating and storage temperature ranges may differ among components, so operating or storing the device outside these ranges may impact the performance of specific components.

## GPU—Integrated

The following table lists the specifications of the integrated Graphics Processing Unit (GPU) supported by your Dell Pro Max Micro FCM2250.

**Table 15. GPU—Integrated**

Controller	Memory size	Processor
Intel Graphics	Shared system memory	Intel Core Ultra 9/7/5

## Multiple display support matrix

The following table lists the multiple display support matrix for your Dell Pro Max Micro FCM2250.

**Table 16. Multiple display support matrix**

Description	Option
Integrated Graphics Card	Intel Graphics
Optional Module	<ul style="list-style-type: none"> <li>HDMI 2.1 FRL - 5120 x 3200 at 60 Hz</li> <li>DisplayPort 2.1 (UHBR20) - Up to 7680 x 4320 at 60 Hz</li> <li>VGA - Up to 1920 x 1200 at 60 Hz</li> <li>USB Type-C with DisplayPort Alt Mode - Up to 5120 x 3200 at 60 Hz</li> </ul>
Supported 4K Displays	<ul style="list-style-type: none"> <li>Onboard DisplayPort 1.4a (HBR3)</li> <li>Optional module HDMI 2.1</li> <li>Optional module DisplayPort 2.1</li> <li>Optional module USB Type-C with DisplayPort Alt Mode</li> </ul>
Supported 5K Displays	<ul style="list-style-type: none"> <li>Optional module DisplayPort 2.1</li> <li>Optional module USB Type-C with DisplayPort Alt Mode</li> <li>Optional module HDMI 2.1</li> </ul>

## GPU—Discrete

The following table lists the specifications of the discrete Graphics Processing Unit (GPU) supported by your Dell Pro Max Micro FCM2250.

**Table 17. GPU—Discrete**

Controller	Memory size	Memory type
NVIDIA RTX A400	4 GB	GDDR6

**Table 17. GPU—Discrete (continued)**

Controller	Memory size	Memory type
NVIDIA RTX A1000	8 GB	GDDR6
NVIDIA RTX 2000 Ada Generation	16 GB	GDDR6
NVIDIA RTX 4000 SFF Ada Generation	20 GB	GDDR6

## Video port resolution

The following table lists the video port resolution for your Dell Pro Max Micro FCM2250.

**Table 18. Video port resolution**

Graphics card	Video ports	Maximum supported resolution
NVIDIA RTX A400	Four mini-DisplayPort 1.4a connectors	Up to 7680 x 4320 at 24 bpb at 120 Hz <i>i</i> <b>NOTE:</b> Requires two DisplayPort 1.4a and DSC. DisplayPort 1.2 Certified, DisplayPort 1.3 and 1.4 ready.
NVIDIA RTX A1000	Four mini-DisplayPort 1.4a connectors	Up to 7680 x 4320 at 24 bpb at 120 Hz <i>i</i> <b>NOTE:</b> Requires two DisplayPort 1.4a and DSC. DisplayPort 1.2 Certified, DisplayPort 1.3 and 1.4 ready.
NVIDIA RTX 2000 Ada Generation	Four mini-DisplayPort 1.4a connectors	Up to 7680 x 4320 at 24 bpb at 120 Hz <i>i</i> <b>NOTE:</b> Requires two DisplayPort 1.4a and DSC. DisplayPort 1.2 Certified, DisplayPort 1.3 and 1.4 ready.
NVIDIA RTX 4000 SFF Ada Generation	Four mini-DisplayPort 1.4a connectors	Up to 7680 x 4320 at 24 bpb at 120 Hz <i>i</i> <b>NOTE:</b> Requires two DisplayPort 1.4a and DSC. DisplayPort 1.2 Certified, DisplayPort 1.3 and 1.4 ready.

# Hardware security

The following table lists the hardware security of your Dell Pro Max Micro FCM2250.

**Table 19. Hardware security**

Hardware security
Kensington security-cable slot
Padlock loop
Chassis intrusion switch
Chassis lock slot support
Lockable cable covers
Supply chain tamper alerts
SafelD including Trusted Platform Module (TPM) 2.0
Smart card keyboard (FIPS)
Microsoft 10 Device Guard and Credential Guard (Enterprise SKU)
Microsoft Windows BitLocker
Local hard drive data wipe through BIOS (Secure Erase)
Self-encrypting storage drives (Opal, FIPS)
Trusted Platform Module TPM 2.0
China TPM
Intel Secure Boot
Intel Authenticate
SafeBIOS: includes Dell Off-host BIOS
Verification, BIOS Resilience, BIOS Recovery, and additional BIOS Controls

# Environmental

The following table lists the environmental specifications of your Dell Pro Max Micro FCM2250.

**Table 20. Environmental**

Feature	Values
Recyclable packaging	Yes
BFR/PVC—free chassis	No
Vertical orientation packaging support	No
Multi-Pack packaging	Yes
Energy-Efficient Power Supply	Standard

**Table 20. Environmental (continued)**

Feature	Values
ENV0424 compliant	Yes

## Regulatory compliance

The following table lists the regulatory compliance of your Dell Pro Max Micro FCM2250.

**Table 21. Regulatory compliance**

Regulatory compliance
<a href="#">Product Safety, EMC and Environmental Datasheets</a>
<a href="#">Dell Regulatory Compliance Home Page</a>
<a href="#">Responsible Business Alliance policy</a>

## Operating and storage environment

This table lists the operating and storage specifications of your Dell Pro Max Micro FCM2250.

**Airborne contaminant level:** G1 as defined by ISA-S71.04-1985

**Table 22. Computer environment**

Description	Operating	Storage
Temperature range	0°C to 35°C (32°F to 95°F)	-40°C to 65°C (-40°F to 149°F)
Relative humidity (maximum)	20% to 80% (non-condensing)	0% to 95% (non-condensing)
Vibration (maximum)*	0.52 GRMS	2.0 GRMS
Shock (maximum)	40 G†, 2.5 ms	105 G†, 2.5 ms
Altitude range	-15.2 m to 3048 m (4.64 ft to 5518.4 ft)	-15.2 m to 10668 m (4.64 ft to 19234.4 ft)

 **CAUTION: Operating and storage temperature ranges may differ among components, so operating or storing the device outside these ranges may impact the performance of specific components.**

\* Measured using a random vibration spectrum that simulates the user environment.

† Measured using a 2 ms half-sine pulse.

## Dell support policy

For information about Dell support policy, search [Dell Support Site](#).

## Dell Optimizer

This section details the Dell Optimizer specifications of your Dell Pro Max Micro FCM2250.

Dell Optimizer is an AI-based software application that allows you to customize your computer settings for power and more. Learn more: [Optimizer at Dell Site](#)

For Dell Pro Max Micro FCM2250 with Dell Optimizer, you can:

- Tune the performance, power consumption, cooling, and fan noise with selectable thermal modes.
- Download and redeem the apps that are purchased with your computer.









For more information about configuring and using these features, see [Dell Optimizer User Guide](#).



# Working inside your computer

## Safety instructions

Use the following safety guidelines to protect your computer from potential damage and to ensure your personal safety. Unless otherwise noted, each procedure in this document assumes that you have read the safety information that shipped with your computer.



-  **WARNING:** Before working inside your computer, read the safety information that is shipped with your computer. For more safety best practices, see [Dell Regulatory Compliance Home Page](#).
-  **WARNING:** Disconnect your computer from all power sources before opening the computer cover or panels. After you finish working inside the computer, replace all covers, panels, and screws before connecting your computer to an electrical outlet.
-  **WARNING:** For laptops, discharge the battery completely before removing it. Disconnect the AC power adapter from the computer and operate the computer solely on battery power—the battery is fully discharged when the computer no longer turns on when the power button is pressed.
-  **CAUTION:** To avoid damaging the computer, ensure that the work surface is flat, dry, and clean.
-  **CAUTION:** You should only perform troubleshooting and repairs as authorized or directed by the Dell technical support team. Damage due to servicing that is not authorized by Dell is not covered by your warranty.
-  **CAUTION:** Before touching anything inside your computer, ground yourself by touching an unpainted metal surface, such as the metal at the back of the computer. While you work, periodically touch an unpainted metal surface to dissipate static electricity which could harm internal components.
-  **CAUTION:** To avoid damaging the components and cards, handle them by their edges, and avoid touching the pins and the contacts.
-  **CAUTION:** When you disconnect a cable, pull it by its connector or its pull tab, not the cable itself. Some cables have connectors with locking tabs or thumbscrews that you must disengage before disconnecting the cable. When disconnecting cables, keep them evenly aligned to avoid bending the connector pins. When connecting cables, ensure that the connector on the cable is correctly oriented and aligned with the port.
-  **CAUTION:** Press and eject any installed card from the media-card reader.

## Before working inside your computer

### About this task

 **NOTE:** The images in this document may differ from your computer depending on the configuration you ordered.

### Steps

1. Save and close all open files and exit all open applications.
2. Shut down your computer. For Windows operating system, click **Start** >  **Power** > **Shut down**.
  -  **NOTE:** If you are using a different operating system, see the documentation of your operating system for shut-down instructions.
3. Turn off all the attached peripherals.
4. Disconnect your computer from the electrical outlet.

5. Disconnect all attached network devices and peripherals, such as keyboard, mouse, and monitor from your computer.

 **CAUTION: To disconnect a network cable, unplug the cable from your computer.**

6. Remove any media card and optical disc from your computer, if applicable.

## Safety precautions

This section details the primary steps to be followed before disassembling any device or component.

Observe the following safety precautions before any installation or break-fix procedures involving disassembly or reassembly:

- Turn off the computer and all attached peripherals.
- Disconnect the computer from AC power.
- Disconnect all network cables and peripherals from the computer.
- Use an ESD field service kit when working inside your computer to avoid electrostatic discharge (ESD) damage.
- Place the removed component on an anti-static mat after removing it from the computer.
- Press and hold the power button for 15 seconds to discharge the residual power in the system board.

## Bonding

Bonding is a method for connecting two or more grounding conductors to the same electrical potential. This is done by using a field service electrostatic discharge (ESD) kit. When connecting a bonding wire, ensure that it is connected to bare metal and never to a painted or nonmetal surface. Ensure that the wrist strap is secure and in full contact with your skin. Remove all jewelry, watches, bracelets, or rings before grounding yourself and the equipment.

## Electrostatic discharge—ESD protection

ESD is a major concern when you handle electronic components, especially sensitive components such as expansion cards, processors, memory modules, and system boards. A slight charge can damage circuits in ways that may not be obvious, such as intermittent problems or a shortened product life span. As the industry pushes for lower power requirements and increased density, ESD protection is an increasing concern.

Two recognized types of ESD damage are catastrophic and intermittent failures.

- **Catastrophic** – Catastrophic failures represent approximately 20 percent of ESD-related failures. The damage causes an immediate and complete loss of device functionality. An example of catastrophic failure is a memory module that has received a static shock and immediately generates a "No POST/No Video" symptom with a beep code that is emitted for missing or nonfunctional memory.
- **Intermittent** – Intermittent failures represent approximately 80 percent of ESD-related failures. The high rate of intermittent failures means that most of the time when damage occurs, it is not immediately recognizable. The memory module receives a static shock, but the tracing is merely weakened and does not immediately produce outward symptoms that are related to the damage. The weakened trace may take weeks or months to melt, and in the meantime may cause degradation of memory integrity, intermittent memory errors, and so on.

Intermittent failures that are also called latent or "walking wounded" are difficult to detect and troubleshoot.

Perform the following steps to prevent ESD damage:

- Use a wired ESD wrist strap that is properly grounded. Wireless anti-static straps do not provide adequate protection. Touching the chassis before handling parts does not ensure adequate ESD protection on parts with increased sensitivity to ESD damage.
- Handle all static-sensitive components in a static-safe area. If possible, use anti-static floor pads and workbench pads.
- When unpacking a static-sensitive component from its shipping carton, do not remove the component from the anti-static packing material until you are ready to install the component. Before unwrapping the anti-static packaging, use the anti-static wrist strap to discharge the static electricity from your body.

 **NOTE:** You can protect against ESD and discharge static electricity from your body by touching a metal-grounded object before you interact with anything electronic, for example, an unpainted metal surface on your computer's I/O panel. When connecting a peripheral (including handheld digital assistants) to your computer, you should always ground both yourself and the peripheral before connecting it to the computer. In addition, as you work inside the computer, periodically touch a metal-grounded object to remove any static charge that your body may have accumulated.

For more information about the wrist strap and ESD wrist strap tester, see [Components of an ESD Field Service Kit](#).

- Before transporting a static-sensitive component, place it in an anti-static container or packaging.

## ESD Field Service kit

The unmonitored field service kit is the most commonly used service kit. Each Field Service kit includes three main components: anti-static mat, wrist strap, and bonding wire.

 **CAUTION:** It is critical to keep ESD-sensitive devices away from internal parts that are insulated and often highly charged, such as plastic heat sink casings.

## Working environment

Before the ESD Field Service kit is deployed, conduct an evaluation of the site to ensure proper setup and readiness. For example, deploying the kit for a server environment is different than for a desktop or laptop environment. Servers are typically installed in a rack within a data center; desktops or laptops are typically placed on office desks or cubicles. Always look for a large open flat work area that is free of clutter and large enough to deploy the ESD kit with additional space to accommodate the type of computer that is being repaired. The workspace should also be free of insulators that can cause an ESD event. On the work area, insulators such as styrofoam and other plastics should always be moved at least 12 inches or 30 centimeters away from sensitive parts before physically handling any hardware components.

## ESD packaging

All ESD-sensitive devices must be shipped and received in static-safe packaging. Metal, static-shielded bags are preferred. However, you should always return the damaged component using the same ESD bag and packaging that the new part arrived in. The ESD bag should be folded over and taped shut and all the same foam packing material should be used in the original box that the new part arrived in. ESD-sensitive devices should be removed from packaging only at an ESD-protected work surface, and parts should never be placed on top of the ESD bag because only the inside of the bag is shielded. Always place parts in your hand, on the anti-static mat, in the computer, or inside an ESD bag.

## Components of an ESD Field Service kit

The components of an ESD Field Service kit are:

- **Anti-Static Mat** – The anti-static mat is dissipative and parts can be placed on it during service procedures. When using an anti-static mat, your wrist strap should be snug and the bonding wire should be connected to the anti-static mat and to any bare metal on the computer being worked on. Once deployed properly, service parts can be removed from the ESD bag and placed directly on the anti-static mat. ESD-sensitive items are safe in your hand, on the anti-static mat, in the computer, or inside an ESD bag.
- **Wrist Strap and Bonding Wire** – If an anti-static mat is not being used, the wrist strap and bonding wire should be connected directly between your wrist and an exposed metal part of the hardware. If you are using an anti-static mat, connect the wrist strap and bonding wire to the anti-static mat to ensure protection for any hardware placed on the mat. The physical connection of the wrist strap and bonding wire between your skin, the anti-static mat, and the hardware is known as bonding. Use only Field Service kits with a wrist strap, anti-static mat, and bonding wire. Never use wireless wrist straps. Always be cautious that the internal wires of a wrist strap are prone to damage from normal wear and tear, and must be checked regularly with a wrist strap tester in order to avoid accidental ESD hardware damage. It is recommended to test the wrist strap and bonding wire at least once per week.
- **ESD Wrist Strap Tester** – The wires inside an ESD strap are prone to damage over time. When using an unmonitored ESD kit, it is recommended to test the wrist strap regularly—ideally before each service session, and at a minimum, once per week. The most reliable method for testing is with a wrist strap tester. To perform the test, connect the bonding wire of the wrist strap to the tester while wearing the strap. Press the test button to initiate the check. A green LED indicates a successful test, while a red LED and audible alarm signal a failure.

 **NOTE:** It is recommended to always use the traditional wired ESD grounding wrist strap and protective anti-static mat when servicing Dell products. In addition, it is critical to keep sensitive parts separate from all insulator parts while servicing the computer.

## Transporting sensitive components

When transporting ESD sensitive components such as replacement parts or parts to be returned to Dell, it is critical to place these parts in anti-static bags for safe transport.

### Lifting equipment

Adhere to the following guidelines when lifting heavy equipment:

 **CAUTION: Do not lift greater than 50 pounds. Always obtain additional resources or use a mechanical lifting device.**

1. Get a firm balanced footing. Keep your feet apart for a stable base, and point your toes out.
2. Tighten stomach muscles. Abdominal muscles support your spine when you lift, offsetting the force of the load.
3. Lift with your legs, not your back.
4. Keep the load close. The closer it is to your spine, the less force it exerts on your back.
5. Keep your back upright, whether lifting or setting down the load. Do not add the weight of your body to the load. Avoid twisting your body and back.
6. Follow the same technique in reverse to set the load down.

## After working inside your computer

### About this task

 **CAUTION: Leaving stray or loose screws inside your computer may severely damage your computer.**

### Steps

1. Replace all screws and ensure that no stray screws remain inside your computer.
2. Connect any external devices, peripherals, or cables you removed before working on your computer.
3. Replace any media cards, discs, or any other components that you removed before working on your computer.
4. Connect your computer and all attached devices to their electrical outlets.
5. Turn on your computer.

## BitLocker

When updating the BIOS on a computer with BitLocker enabled, consider the following precautions.

 **CAUTION: If BitLocker is not suspended before updating the BIOS, the BitLocker key will not be recognized the next time that you reboot the computer. You are prompted to enter the recovery key to progress, and the computer displays a prompt for the recovery key on each reboot. If the recovery key is not known, this can result in data loss or an operating system reinstall. For more information, see Knowledge Article: [updating the BIOS on Dell computers with BitLocker enabled](#).**

The installation of the following components triggers BitLocker:

- Hard disk drive or solid state drive
- System board

## Recommended tools











The procedures in this document may require the following tools:

- Phillips screwdriver #0
- Phillips screwdriver #1
- Plastic scribe











# Screw list

- NOTE:** When removing screws from a component, it is recommended to note the screw type and the quantity of screws, and then place them in a screw storage box. This is to ensure that the correct number of screws and correct screw type is restored when the component is replaced.
- NOTE:** Some computers have magnetic surfaces. Ensure that the screws are not left attached to such surfaces when replacing a component.
- NOTE:** Screw color may vary depending on the configuration ordered.

**Table 23. Screw list**

Component	Screw type	Quantity	Screw image
<b>CRU</b>			
Side cover	#6-32x9.3	1	
Riser-card module	M3x3	2	
M.2 2230 SSD (slot-one/slot-two)	M2x8.5	1	
M.2 2230 SSD (slot-one/slot-two)	M2x6	1	
M.2 2280 SSD (slot-one/slot-two)	M2x8.5	1	
Wireless card	M2x3.5	2	
Speaker holder	M3x5	1	
<b>Option modules</b>			
5G optical fiber port	M3x8.5	1	
	M3x6	2	
PS2 port	M3x8.5	1	
	M3x6	1	

**Table 23. Screw list (continued)**

Component	Screw type	Quantity	Screw image
DisplayPort	M3x8.5	1	
	M3x6	1	
Thunderbolt	M3x8.5	1	
	M3x6	1	
HDMI	M3x8.5	1	
	M3x6	1	
<b>FRU</b>			
Heat sink	Captive (6-32x6.66)	3	
System board	M3x5	3	
	M2x4.8 (Standoff)	1	
Internal antenna - location one	M3x3	1	
Internal antenna - location two	M3x3	1	

## Major components of Dell Pro Max Micro FCM2250

The following image shows the major components of Dell Pro Max Micro FCM2250.

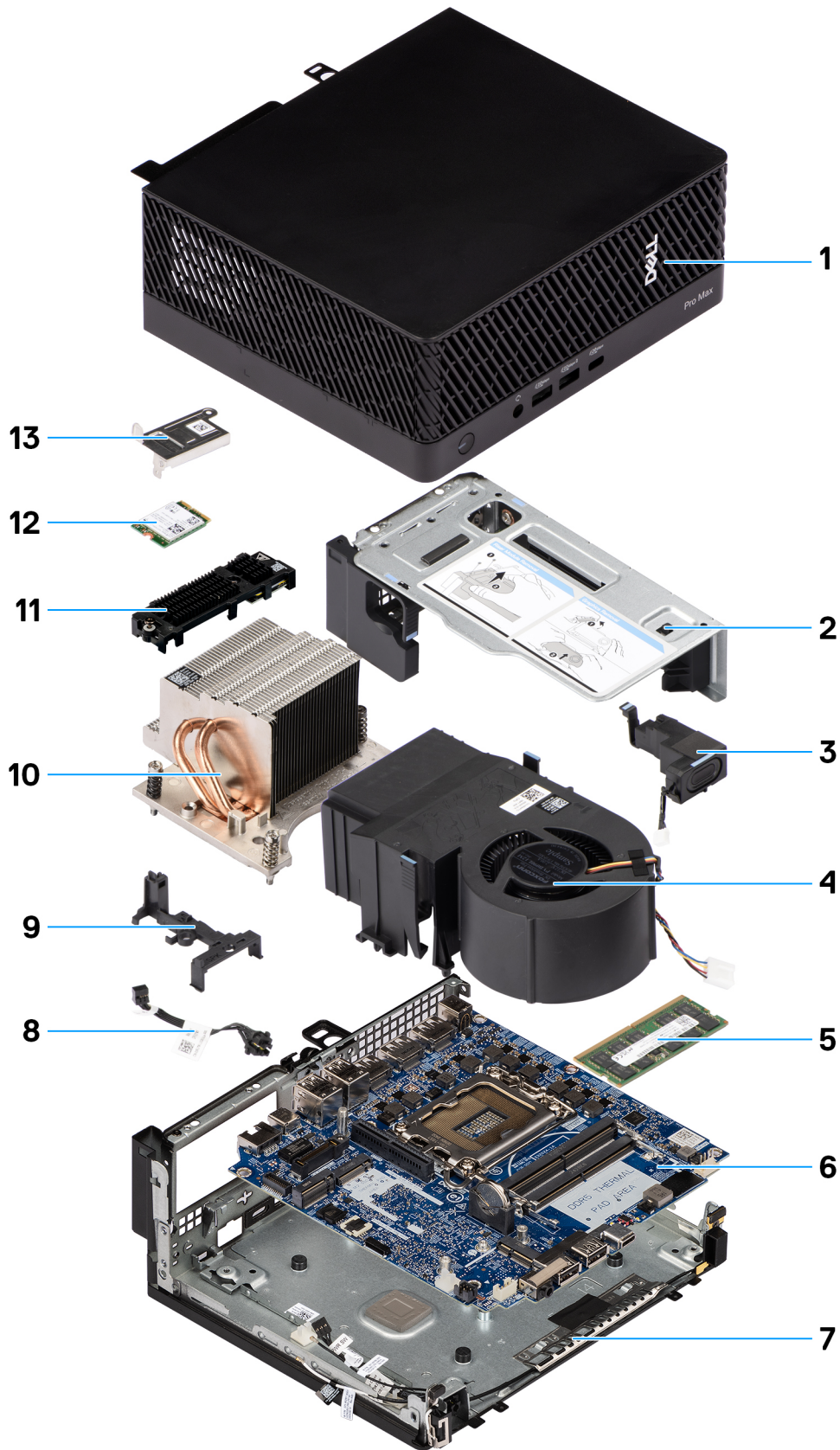

- 1. Side cover
- 3. Speaker
- 5. Memory module
- 7. Chassis

- 2. Riser-card bracket
- 4. System fan
- 6. System board
- 8. Power button

- 9. Speaker holder
- 10. Heat sink
- 11. SSD-extender bracket with M.2 SSD
- 12. Wireless card
- 13. Wireless card bracket

 **NOTE:** Dell provides a list of components and their part numbers for the original computer configuration purchased. These parts are available according to warranty coverage purchased by the customer. Contact your Dell sales representative for purchase options.



# Removing and installing side cover

## Removing the side cover

### Prerequisites

1. Follow the procedure in [before working inside your computer](#).

 **NOTE:** Ensure that you remove the security cable from the security-cable slot (if applicable).

### About this task

The following images indicate the location of the side cover and provide a visual representation of the removal procedure.

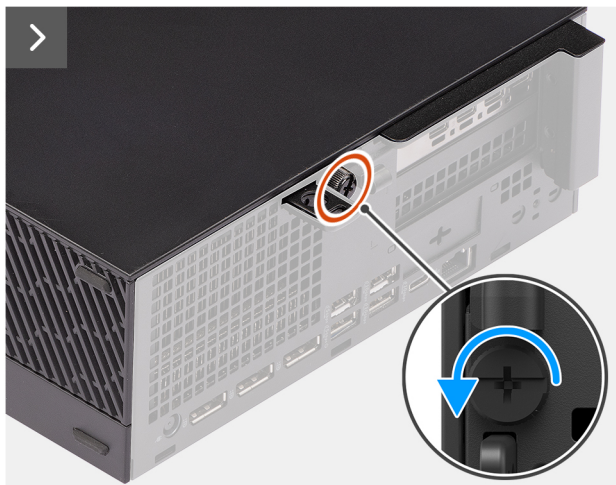
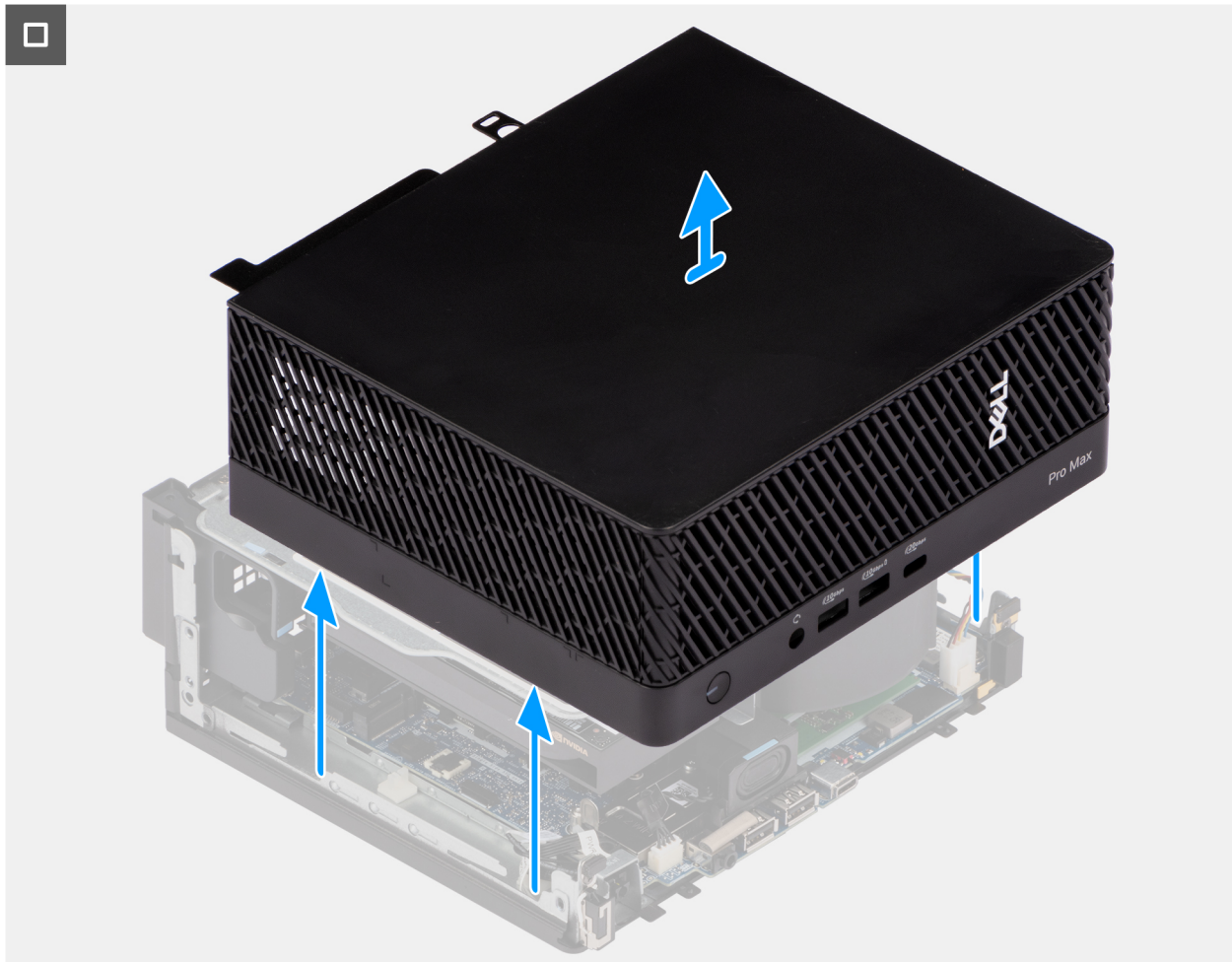

Figure 3. Removing the side cover



**Figure 4. Removing the side cover**

### Steps

1. Loosen the thumbscrew (#6-32x9.3) that secures the side cover to the chassis.
2. Slide the side cover towards the front of the computer to remove the padlock ring through the slot in the chassis.
3. Lift to remove it from the chassis.

## Installing the side cover

### Prerequisites

If you are replacing a component, remove the existing component before performing the installation procedure.

### About this task

The following image indicates the location of the side cover and provides a visual representation of the installation procedure.



1x  
6-32x9-3

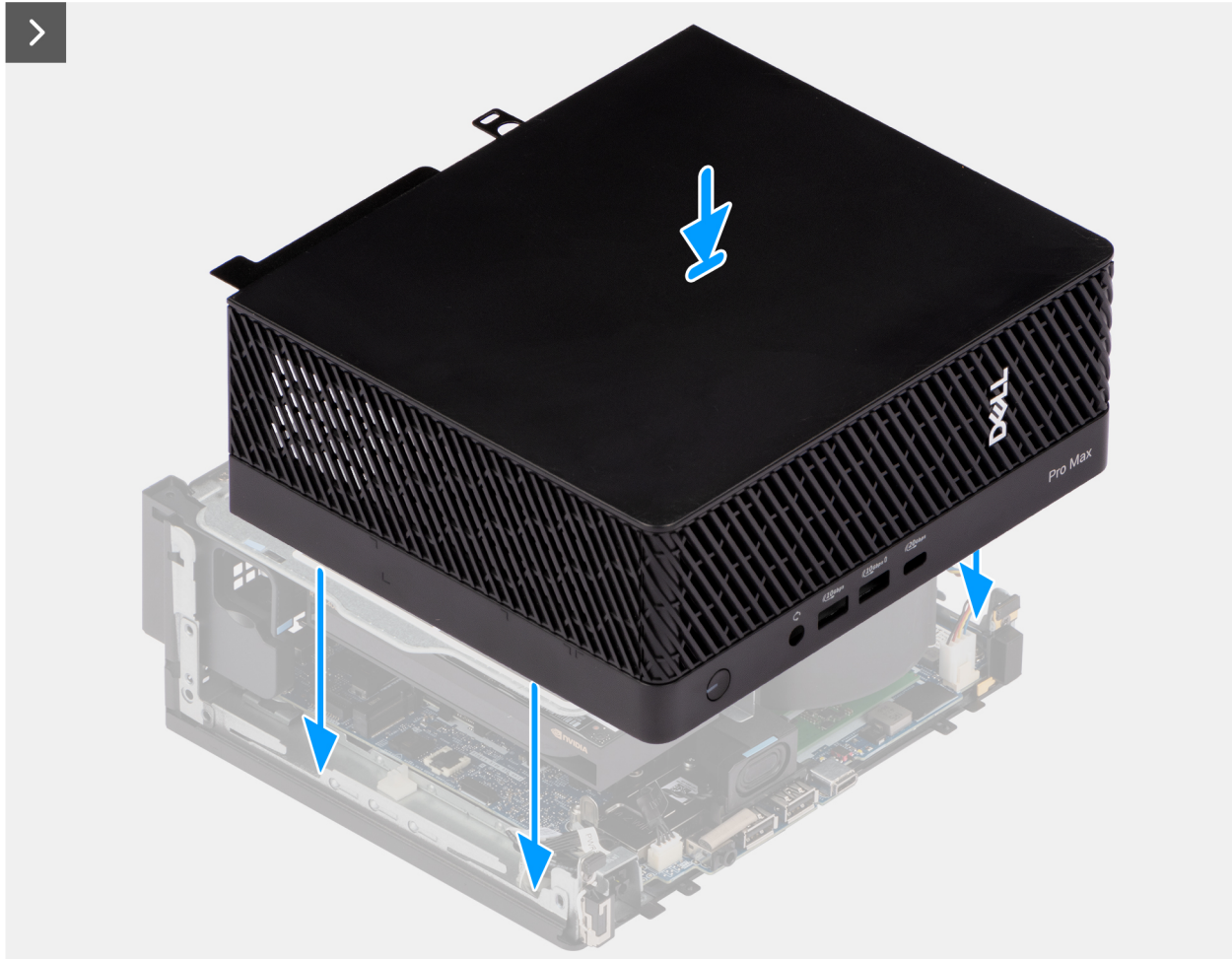

Figure 5. Installing the side cover



**Figure 6. Installing the side cover**

### Steps

1. Align the side cover with the grooves on the chassis.
2. Slide the side cover into the chassis towards the front of the computer.  
**i** **NOTE:** Ensure to slide the padlock ring through the slot in the chassis.
3. Tighten the thumbscrew (#6-32x9.3) to secure the side cover to the chassis.

### Next steps

1. Follow the procedure in [after working inside your computer](#).

# Removing and installing coin-cell battery

## Removing the coin-cell battery

 **CAUTION:** Removing the coin-cell battery clears the CMOS and resets BIOS settings.

### Prerequisites

1. Follow the procedure in [before working inside your computer](#).
2. Remove the [side cover](#).
3. Remove the [riser-card module](#).

### About this task

The following image indicates the location of the coin-cell battery and provides a visual representation of the removal procedure.



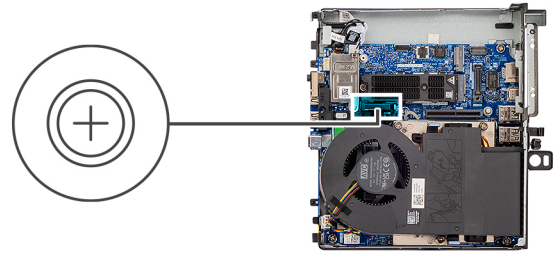

Figure 7. Removing the coin-cell battery

### Steps

1. Pull the tab to open and release the coin-cell battery cover.
2. Push the coin-cell battery securing-clip on the coin-cell battery socket to release the coin-cell battery.
3. Remove the coin-cell battery from the computer.

## Installing the coin-cell battery

### Prerequisites

If you are replacing a component, remove the existing component before performing the installation procedure.

### About this task

The following image indicates the location of the coin-cell battery and provides a visual representation of the installation procedure.

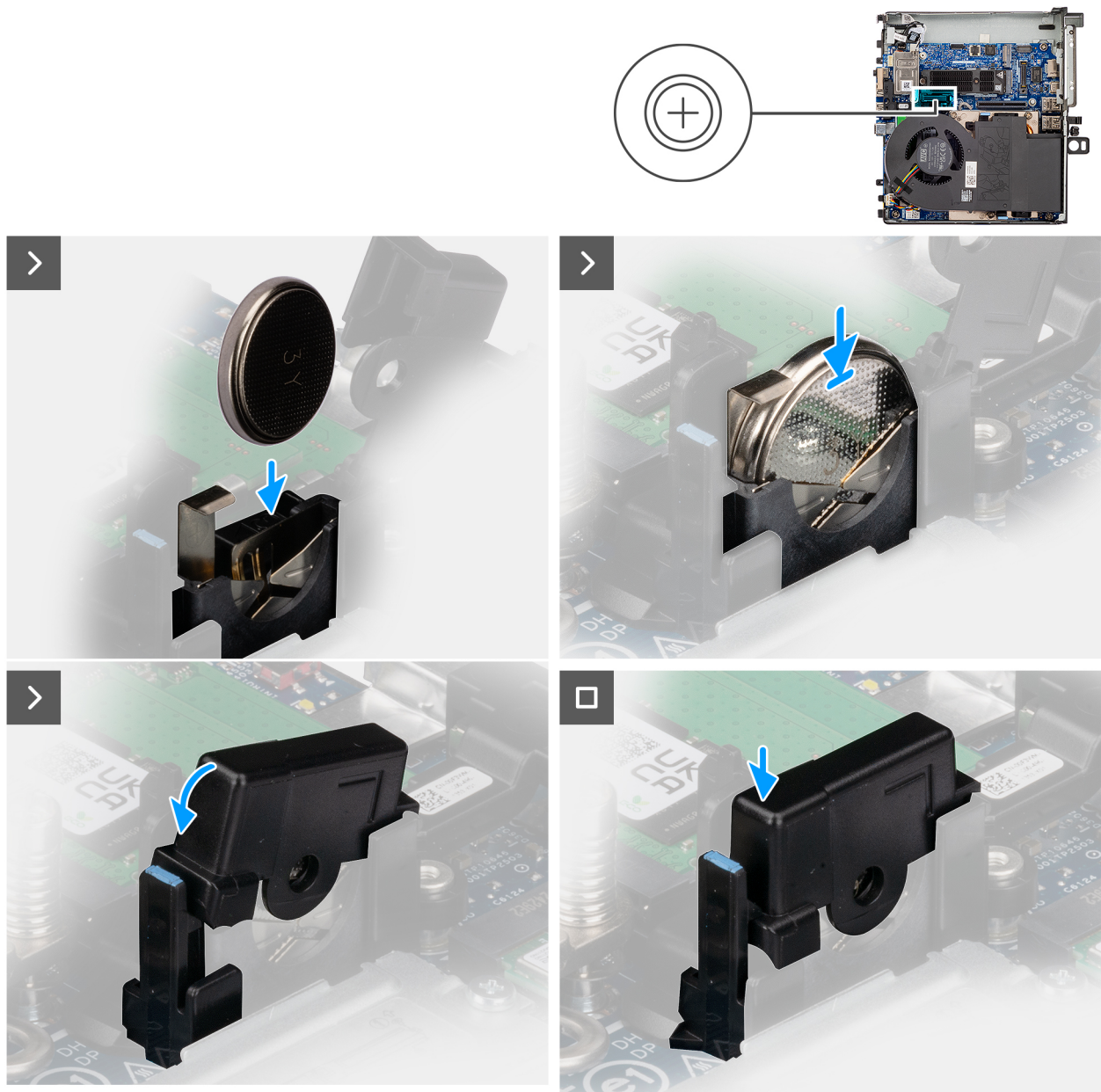

**Figure 8. Installing the coin-cell battery**

### Steps

1. Insert the coin-cell battery into the socket with the positive side (+) label facing up and snap the battery in the socket.
2. Close and press the cover until it latches into place.

### Next steps

1. Install the [riser-card module](#).
2. Install the [side cover](#).
3. Follow the procedure in [after working inside your computer](#).

# Removing and installing Customer Replaceable Units (CRUs)

The replaceable components in this chapter are Customer Replaceable Units (CRUs).

 **CAUTION:** Customers can replace only the Customer Replaceable Units (CRUs) following the safety precautions and replacement procedures.

 **NOTE:** The images in this document may differ from your computer depending on the configuration you ordered.

## Riser-card module

### Removing the riser-card module

#### Prerequisites

 **NOTE:** The riser-card module contains graphic card.

1. Follow the procedure in [before working inside your computer](#).
2. Remove the [side cover](#).

#### About this task

The following image indicates the location of the riser-card module and provides a visual representation of the removal procedure.





2x  
M3x3

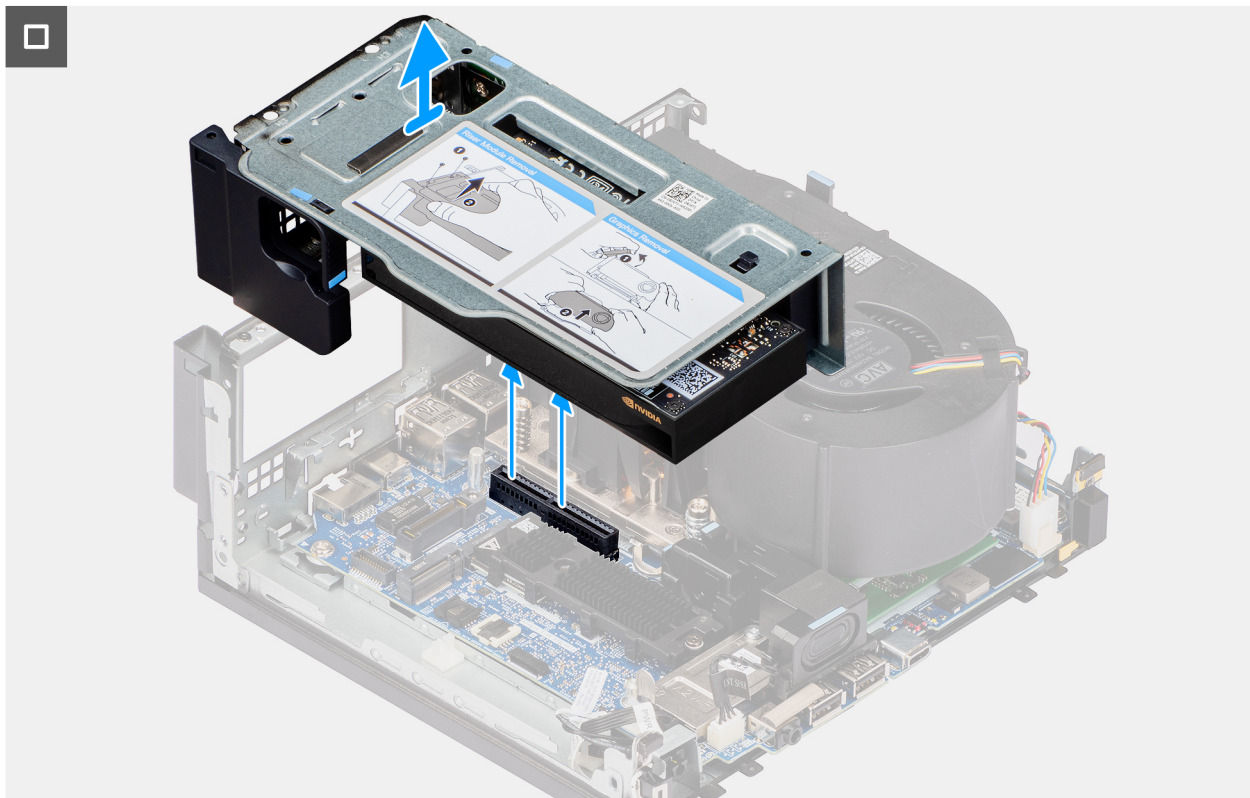

**Figure 9. Removing the riser-card module**

### Steps

1. Remove the two (M3x3) screws that secure the riser-card module to the chassis.
2. Lift the riser-card module away from the computer.

## Installing the riser-card module

### Prerequisites

If you are replacing a component, remove the existing component before performing the installation procedure.

### About this task

The following image indicates the location of the riser-card module and provides a visual representation of the installation procedure.



2x  
M3x3

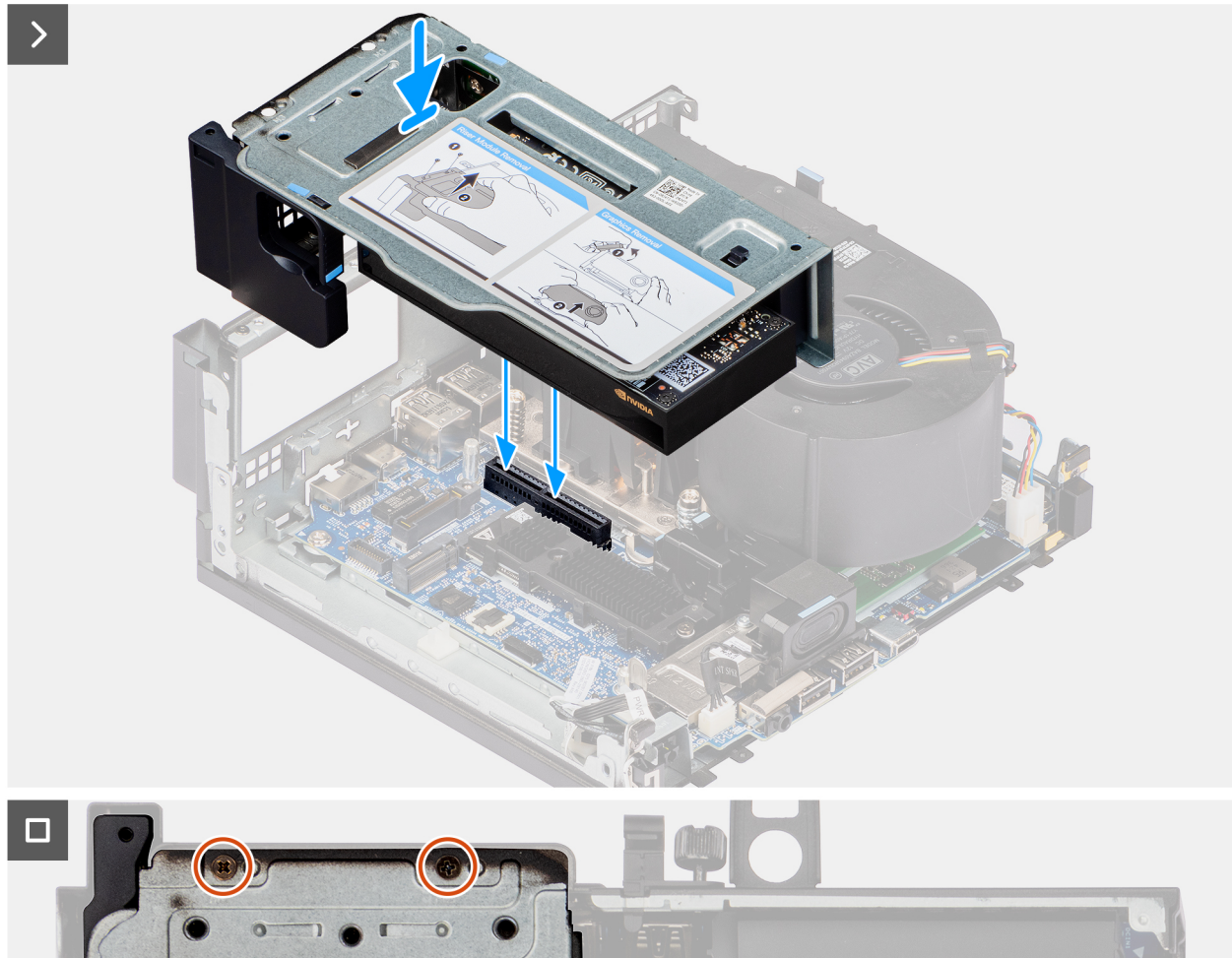

**Figure 10. Installing the riser-card module**

#### Steps

1. Align and place the module on the PCIe slot on the system board.
2. Align the screw holes on the riser-card module with the screw holes on the chassis.
3. Replace the two (M3x3) screws to secure the riser-card module to the chassis.

#### Next steps

1. Install the [side cover](#).
2. Follow the procedure in [after working inside your computer](#).

# Graphics card

## Removing the graphics card

### Prerequisites

1. Follow the procedure in [before working inside your computer](#).
2. Remove the [side cover](#).
3. Remove the [riser-card module](#).

### About this task

The following image indicates the location of the graphics card and provides a visual representation of the removal procedure.

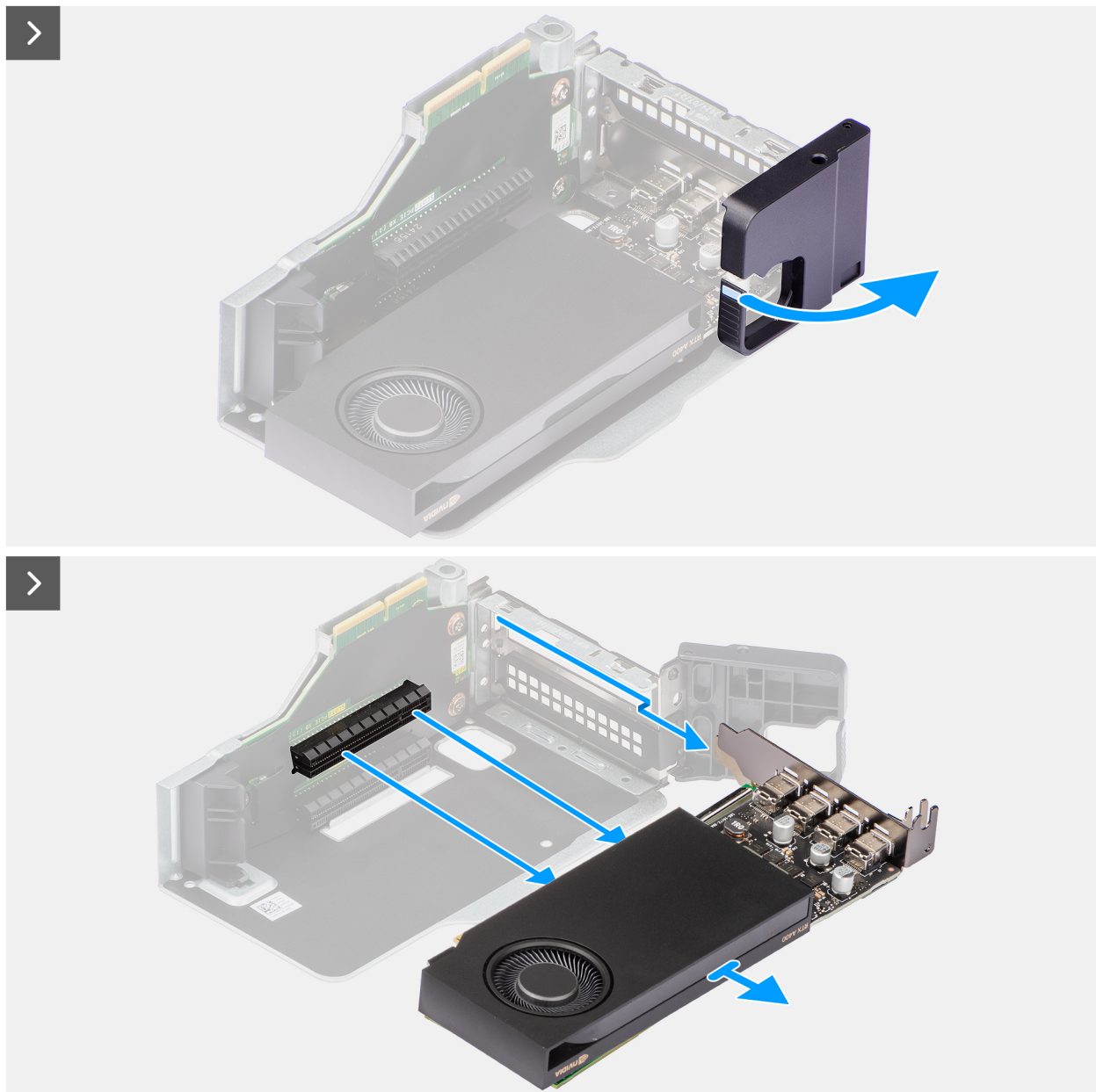
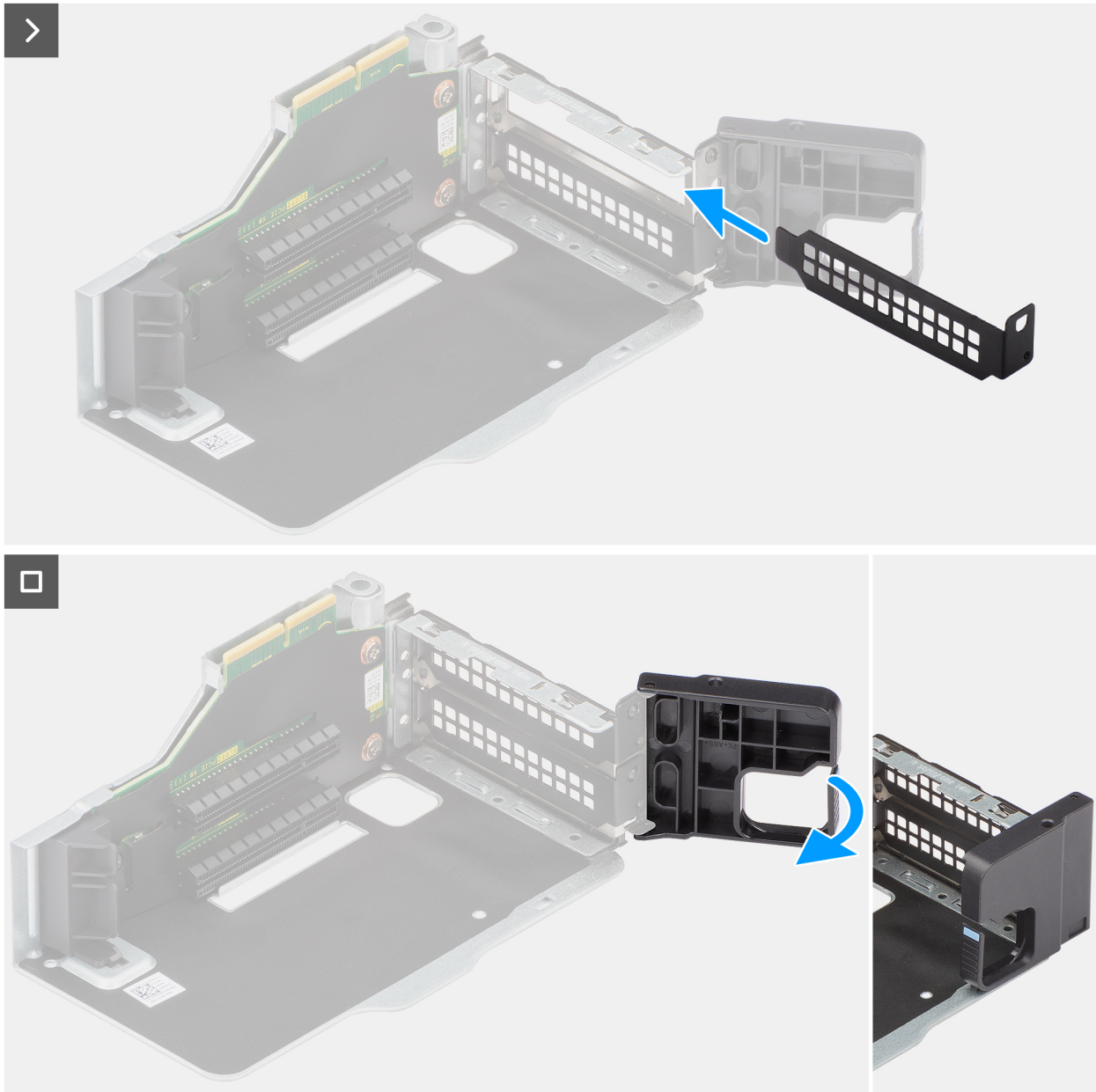

Figure 11. Removing the graphics card





**Figure 12. Removing the graphics card**

**Steps**

1. On the riser-card module, press the retainer arm to release the hook and swing open the retainer.
2. Slide the graphics card along the edges of the riser-card module to detach it.
3. Slide and insert the expansion-card slot-cover into position.
4. Swing the retainer back into the closed position.

**Installing the graphics card**

**Prerequisites**

If you are replacing a component, remove the existing component before performing the installation procedure.

**About this task**

The following image indicates the location of the graphics card and provides a visual representation of the installation procedure.

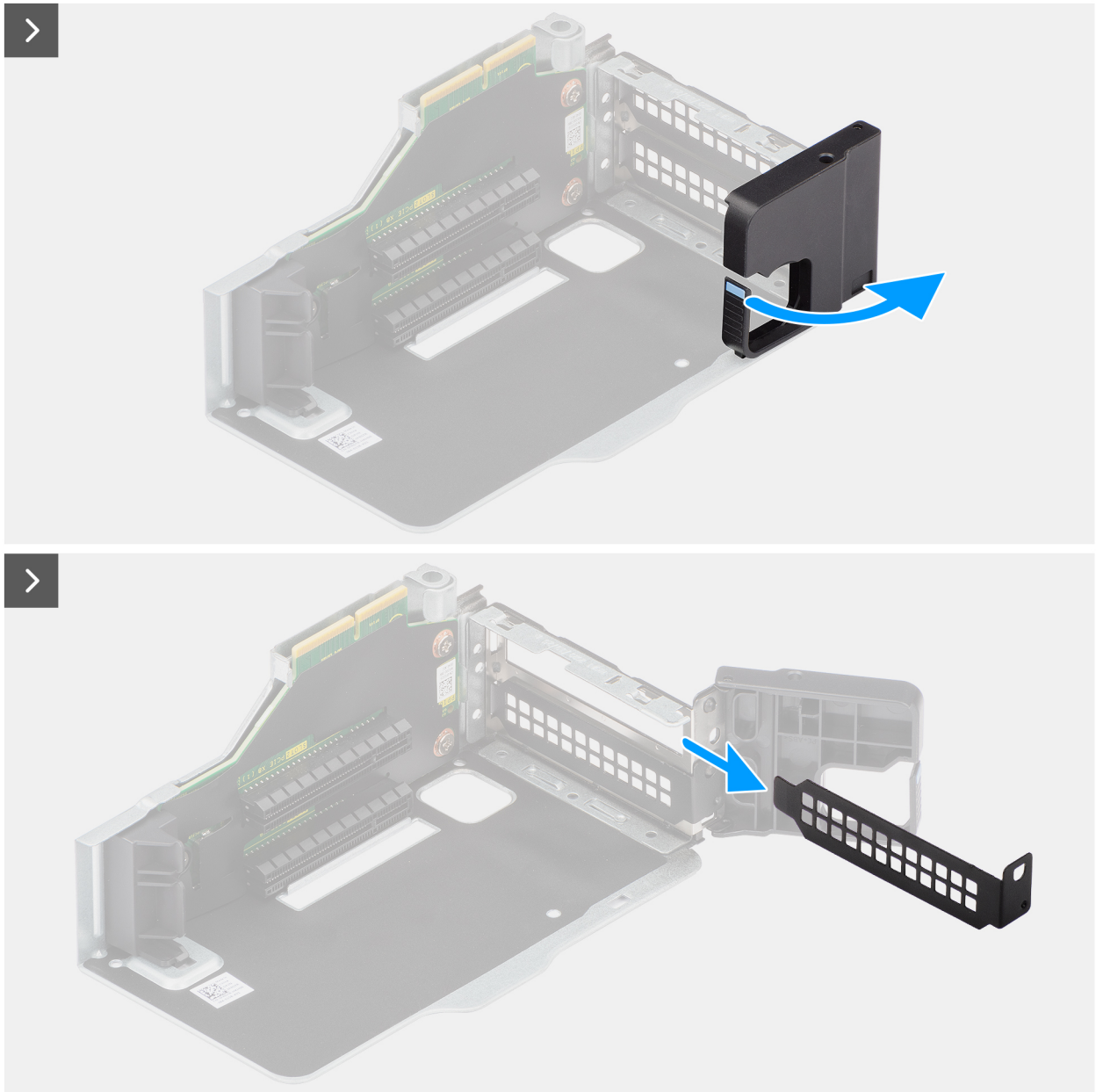
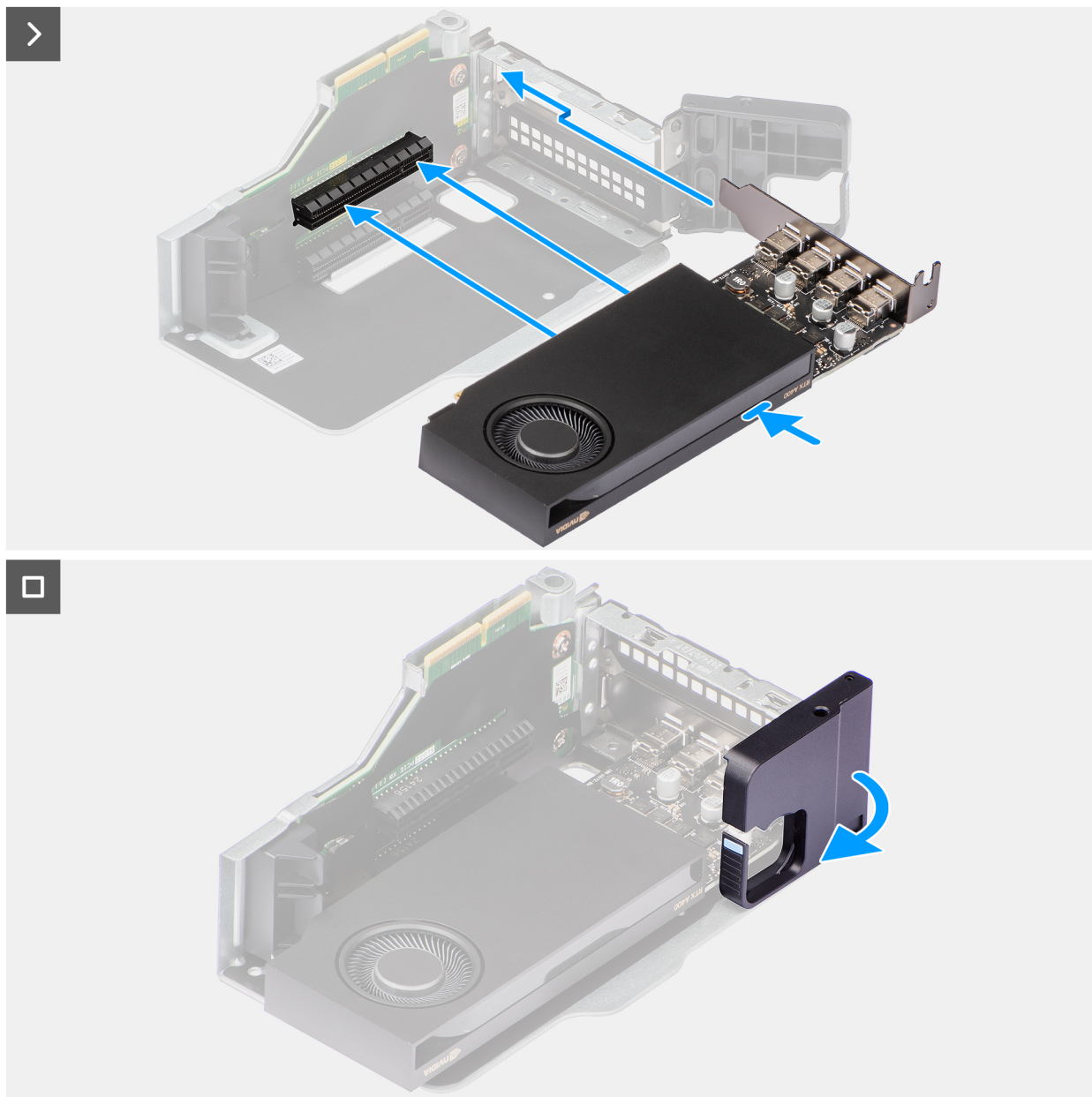

Figure 13. Installing the graphics card



**Figure 14. Installing the graphics card**

#### **Steps**

1. On the riser-card module, press the retainer arm to release the hook and swing open the retainer.
2. Slide to remove the expansion-card slot-cover from the riser-card module.
3. Slide the graphics card into the slot on the riser-card module until it clicks into place securely.
4. Swing the retainer back into the closed position.

#### **Next steps**

1. Install the [riser-card module](#).
2. Install the [side cover](#).
3. Follow the procedure in [after working inside your computer](#).

# System fan

## Removing the system fan

### Prerequisites

1. Follow the procedure in [before working inside your computer](#).
2. Remove the [side cover](#).
3. Remove the [riser-card module](#).

### About this task

The following images indicate the location of the system fan and provide a visual representation of the removal procedure.

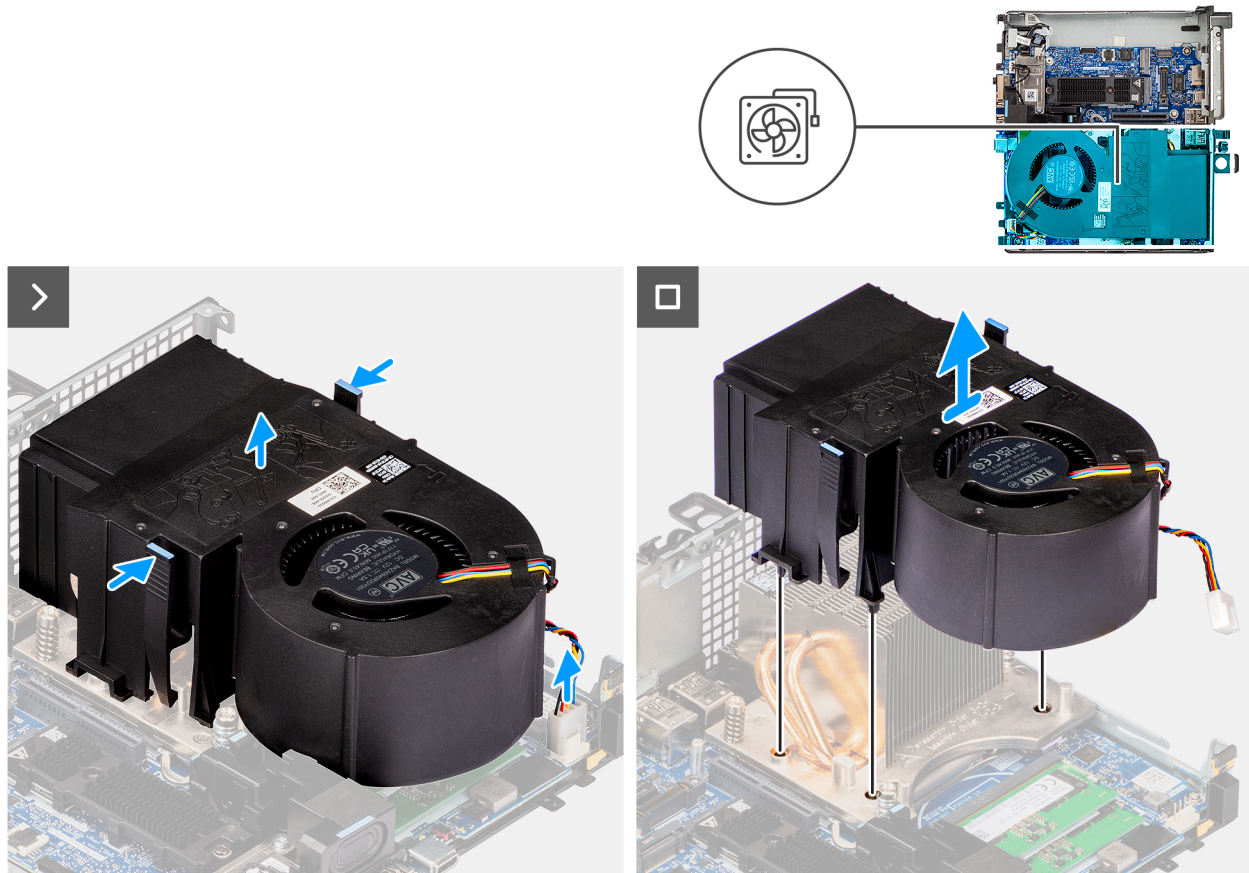

Figure 15. Removing the system fan

### Steps

1. Disconnect the fan cable from the connector (FANC1 and FANC2) on the system board.
2. Press the blue tabs on both sides of the system fan and lift the system fan away from the computer.

## Installing the system fan

### Prerequisites

If you are replacing a component, remove the existing component before performing the installation procedure.

### About this task

The following images indicate the location of the system fan and provide a visual representation of the installation procedure.



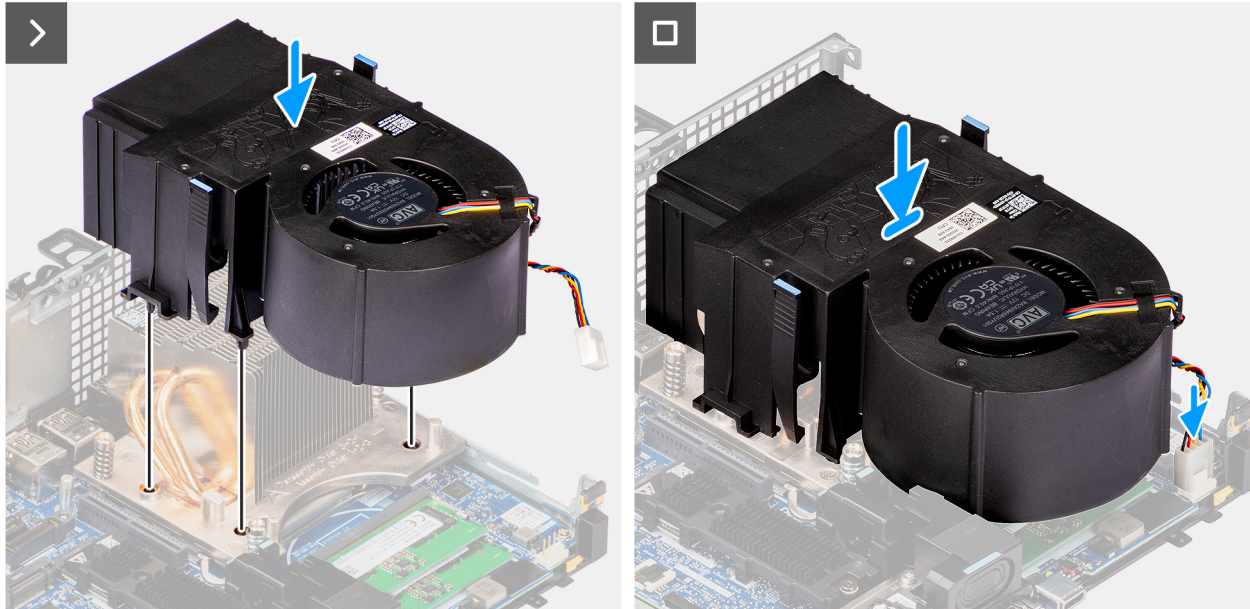
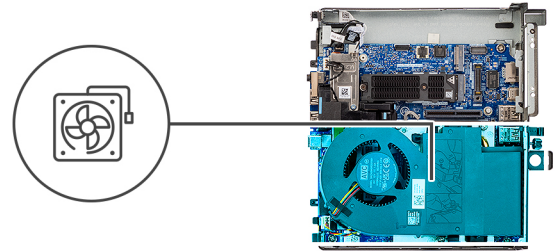

**Figure 16. Installing the system fan**

### Steps

1. Align the stands of the system fan with the mounting holes on the heat sink.
2. Push firmly down onto the system fan until it clicks into place.
3. Connect the fan cable to the connector (FANC1 and FANC2) on the system board.

### Next steps

1. Install the [riser-card module](#).
2. Install the [side cover](#).
3. Follow the procedure in [after working inside your computer](#).

## Memory module

### Removing the memory modules

#### Prerequisites

1. Follow the procedure in [before working inside your computer](#).
2. Remove the [side cover](#).
3. Remove the [riser-card module](#).
4. Remove the [system fan](#).

#### About this task

The following images indicate the location of the memory modules and provide a visual representation of the removal procedure.



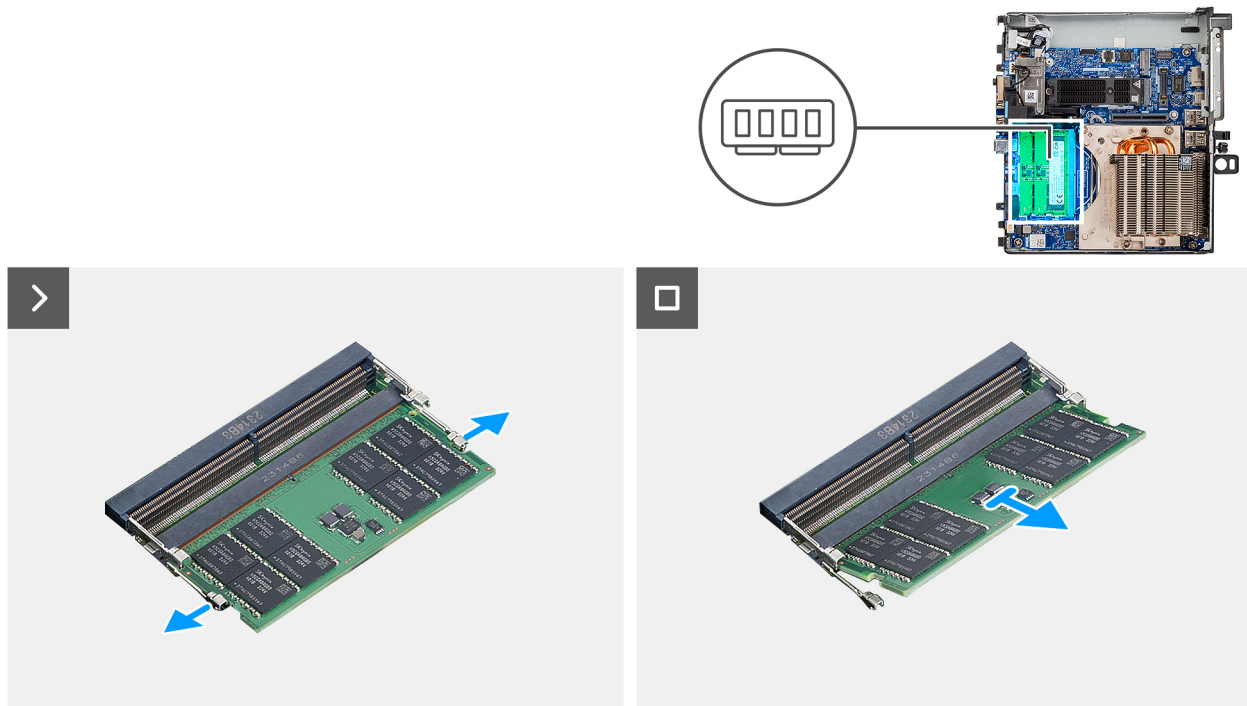

Figure 17. Removing the memory modules

### Steps

1. Place the computer on its side.
2. Pull the securing clips from both sides of the memory module until the memory module pops up.
3. Slide to remove the memory module from the memory-module slot.

**CAUTION:** To prevent damage to the memory module, hold the memory module by the edges. Do not touch the components or metallic contacts on the memory module as electrostatic discharge(ESD) can inflict severe damage on the components. To read more about ESD protection, see [ESD protection](#).

**NOTE:** Repeat step 2 to step 3 to remove any other memory module installed in your computer.

**NOTE:** Note the slot and the orientation of the memory module in order to replace it in the correct slot.

## Installing the memory modules

### Prerequisites

If you are replacing a component, remove the existing component before performing the installation procedure.

### About this task

The following images indicate the location of the memory modules and provide a visual representation of the installation procedure.

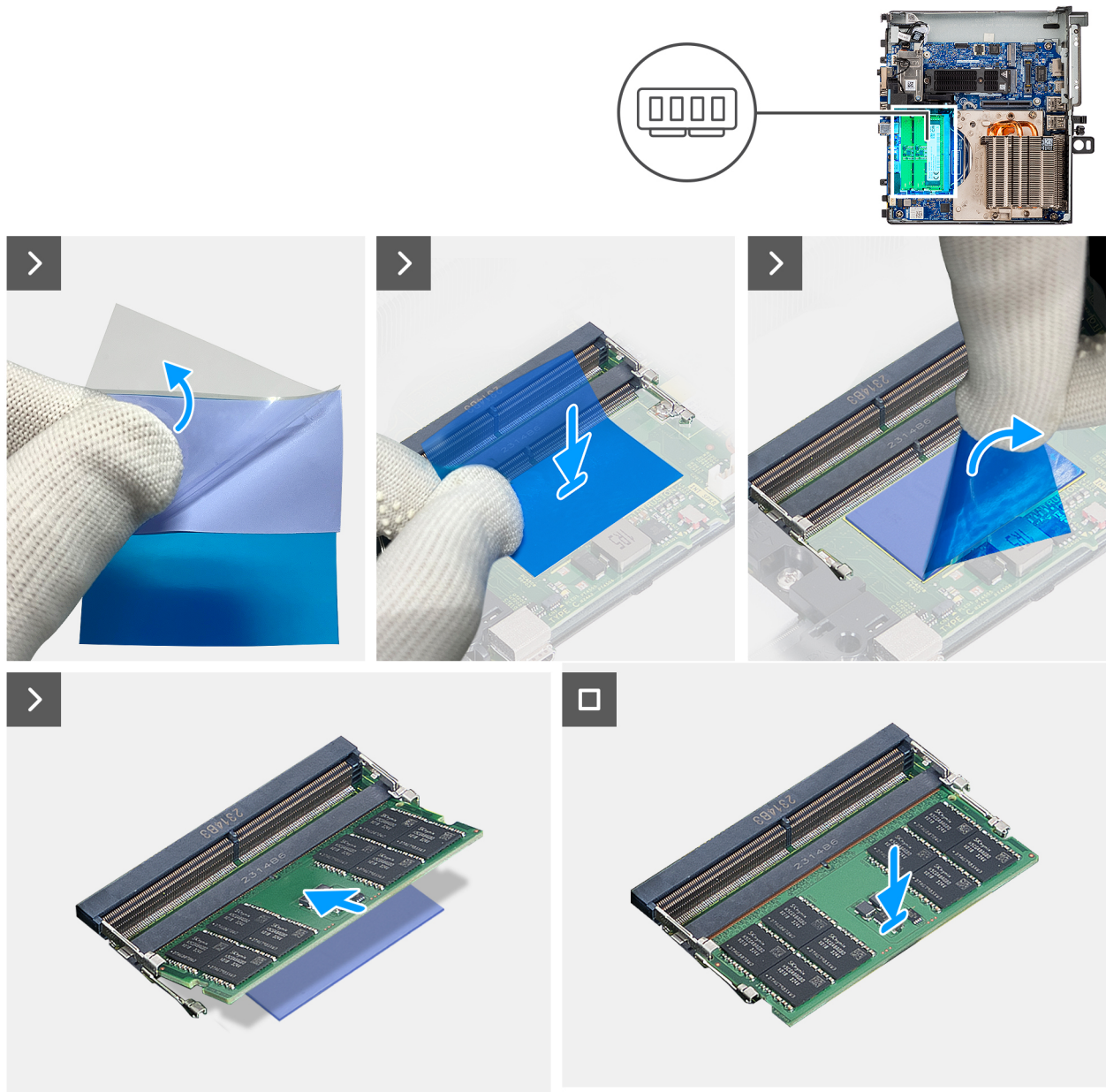

**Figure 18. Installing the memory modules**

### Steps

1. **NOTE:** The replacement memory modules that are purchased from Dell come with thermal pads and must be adhered to the system board.

If the thermal pad needs to be replaced, peel the transparent cover off the new thermal pad.

2. Align the sticky side of the thermal pad to the area of the system board where the memory module is installed.
3. Peel the blue tape off the thermal pad.
4. Align the notch on the memory module with the tab on the memory-module slot.
5. Slide the memory module firmly into the slot at an angle and press the memory module down until it secures into place.

**CAUTION:** To prevent damage to the memory module, hold the memory module by the edges. Do not touch the components or metallic contacts on the memory module as electrostatic discharge (ESD) can inflict severe damage on the components. To read more about ESD protection, see [ESD protection](#).

1. **NOTE:** The securing clips return to the locked position. If you do not hear the click, remove the memory module and reinstall it.

 **NOTE:** Repeat steps 4 to 5 when installing more than one memory module in your computer.

#### Next steps

1. Install the [system fan](#).
2. Install the [riser-card module](#).
3. Install the [side cover](#).
4. Follow the procedure in [after working inside your computer](#).

## Solid-state drive

### Removing the M.2 2230 SSD (slot-one)

#### Prerequisites

1. Follow the procedure in [before working inside your computer](#).
2. Remove the [side cover](#).
3. Remove the [riser-card module](#).

#### About this task

The following images indicate the location of the SSD and provide a visual representation of the removal procedure.

 **NOTE:** The procedure is the same for removal of M.2 2230 SSD from slot-two.

 **NOTE:** There is no M.2 SSD thermal pad in slot-two.

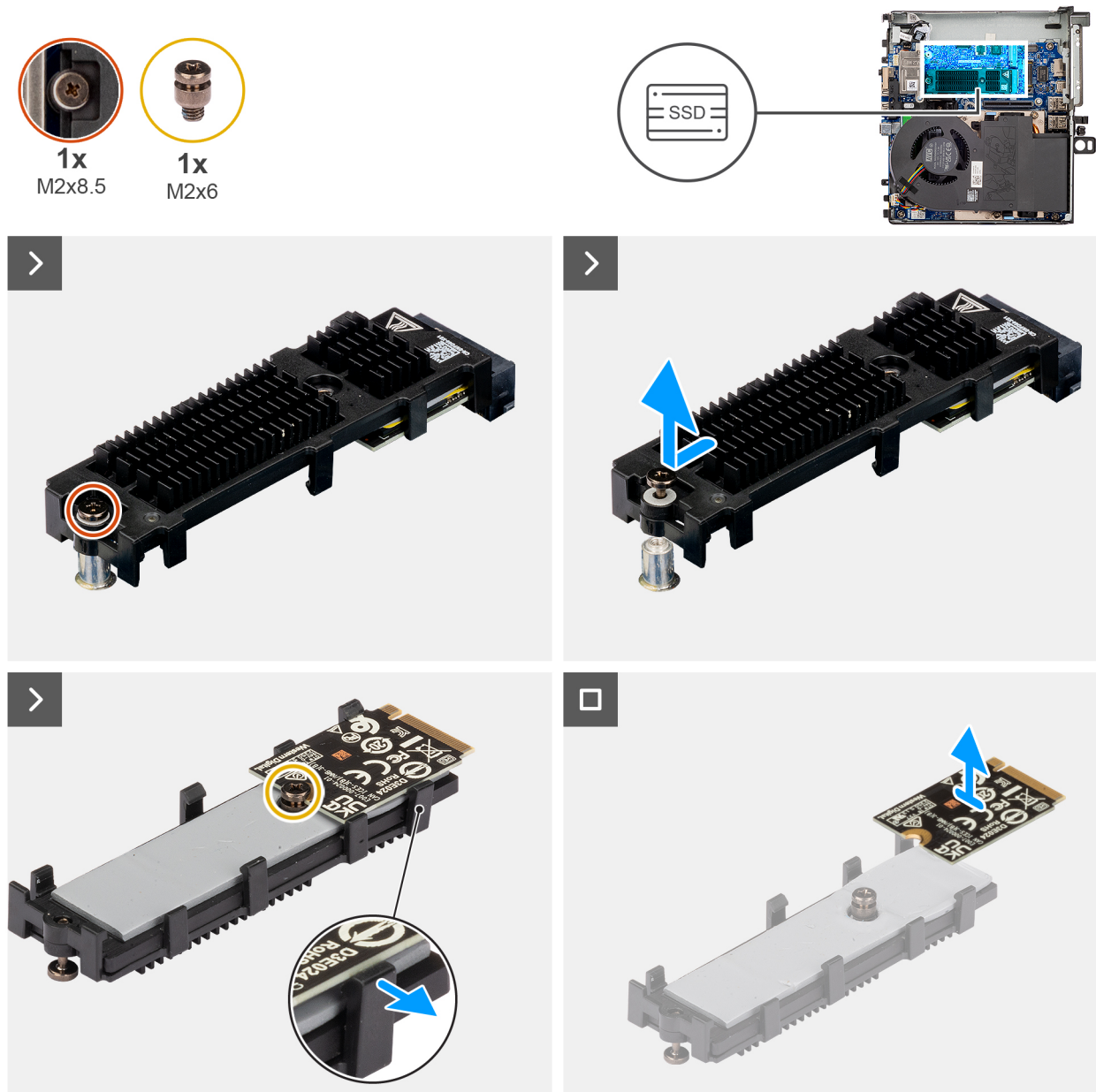

**Figure 19. Removing the M.2 2230 PCIe solid state drive (slot-one)**

#### Steps

1. Loosen the screw (M2x8.5) that secures the SSD-extender bracket to the system board.
2. Slide and lift the SSD-extender bracket from the system board.
3. Flip over the extender bracket.
4. Release the four snaps holding the M.2 2230 SSD card.
5. Remove the M.2 2230 SSD from the extender bracket.

**NOTE:** Repeat steps 1 to 5 for removing M.2 2230 SSD from slot-two (if applicable).

## Installing the M.2 2230 SSD (slot-one)

#### Prerequisites

If you are replacing a component, remove the existing component before performing the installation procedure.



### About this task

The following image indicates the location of the SSD and provides a visual representation of the installation procedure.

**NOTE:** The same procedure applies to installation of M.2 2230 SSD in slot-two.

**NOTE:** There is no thermal pad in slot-two.

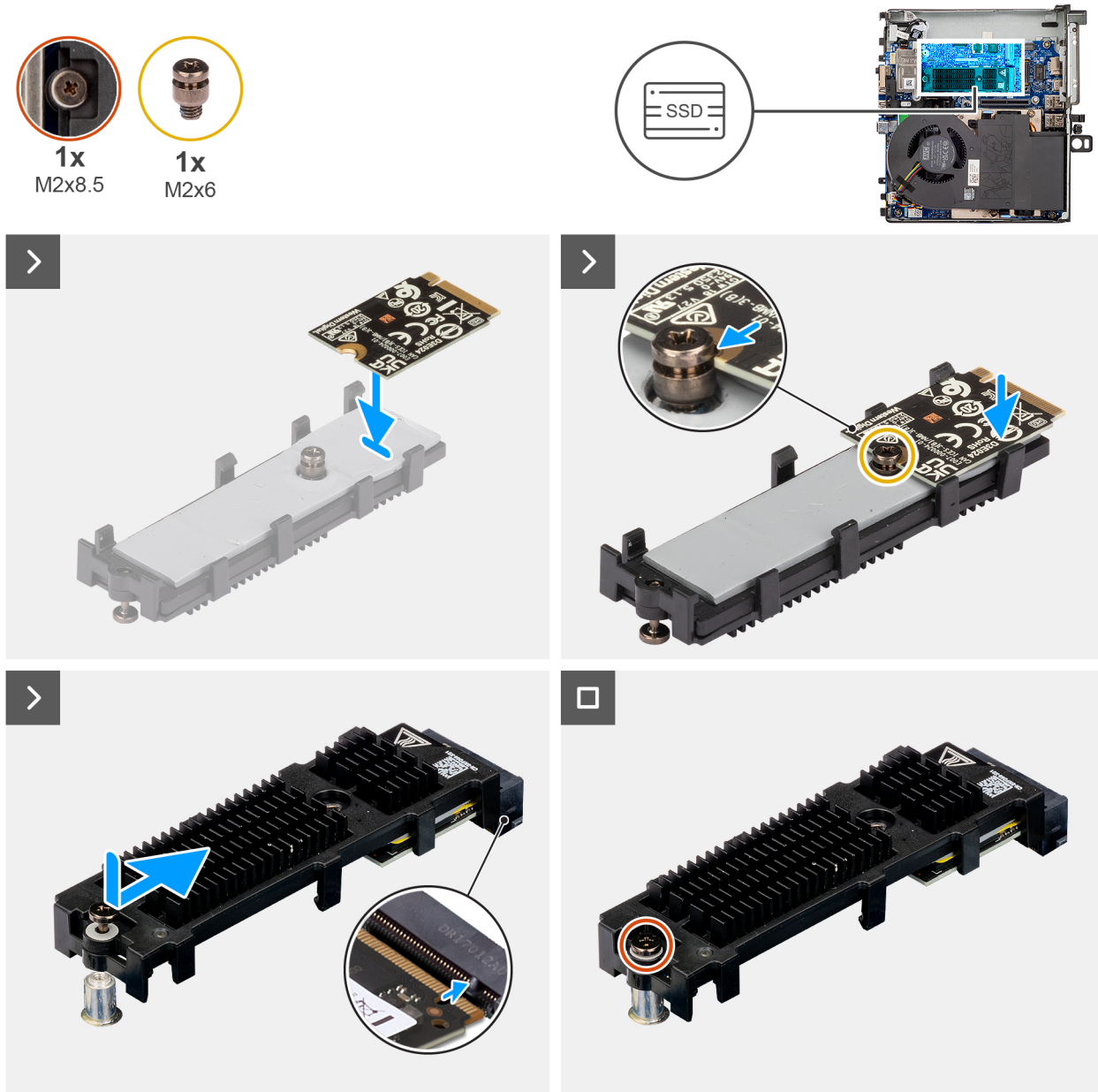

**Figure 20. Installing the M.2 2230 PCIe solid state drive (slot-one)**

### Steps

1. Place the M.2 2230 SSD card on the extender bracket at a 45-degree angle.
2. Align the notch of the card with the screw (M2x6) on the extender bracket.
3. Press down until the M.2 2230 SSD card snaps into place.
4. Flip the extender bracket and align the notch with the tab on the SSD connector on the system board.
5. Insert the SSD-extender bracket at a 45-degree angle into the M.2 connector on the system board.
6. Replace the screw (M2x8.5) that secures the M.2 2230 SSD-extender bracket to the system board.

 **NOTE:** Repeat steps 1 to 6 for installing the M.2 2230 SSD in slot-two (if applicable).

### Next steps

1. Install the [riser-card module](#).
2. Install the [side cover](#).
3. Follow the procedure in [after working inside your computer](#).

## Removing the M.2 2280 SSD (slot-one)

### Prerequisites

1. Follow the procedure in [before working inside your computer](#).
2. Remove the [side cover](#).
3. Remove the [riser-card module](#).

### About this task

The following images indicate the location of the SSD and provide a visual representation of the removal procedure.

 **NOTE:** The same procedure applies to removal of M.2 2280 SSD from slot-two.

 **NOTE:** There is no thermal pad in slot-two.

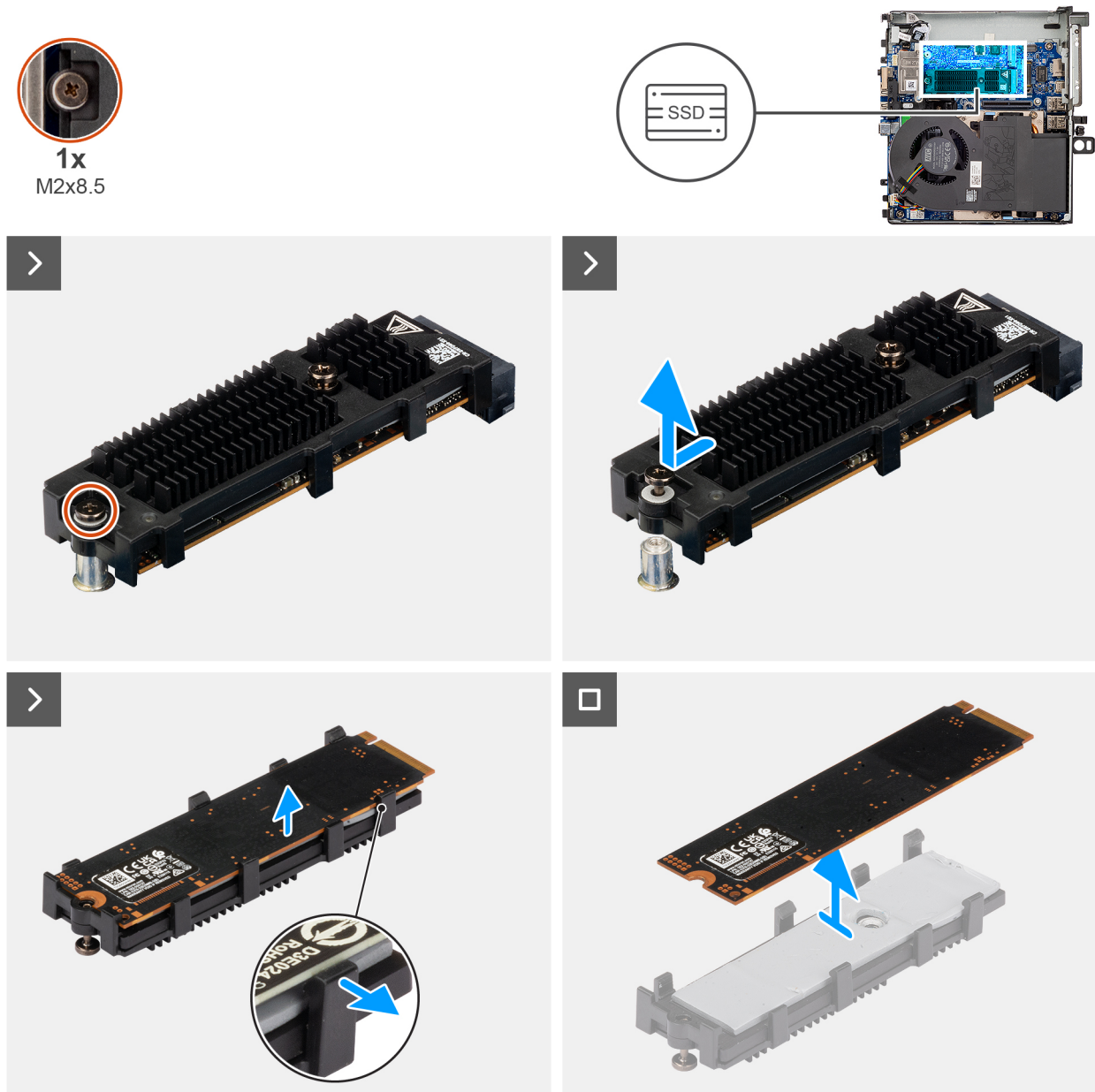

Figure 21. Removing the M.2 2280 PCIe solid state drive (slot-one)

**Steps**

1. Loosen the screw (M2x8.5) that secures the SSD-extender bracket to the system board.
2. Slide and lift the SSD-extender bracket from the system board.
3. Flip over the bracket and remove the M.2 2280 SSD from the extender bracket.

**NOTE:** Repeat steps 1 to 3 for removing M.2 2280 SSD from slot-two (if applicable).

## Installing the M.2 2280 SSD (slot-one)

**Prerequisites**

If you are replacing a component, remove the existing component before performing the installation procedure.

### About this task

The following image indicates the location of the SSD and provides a visual representation of the installation procedure.

**NOTE:** The same procedure applies to installation of M.2 2280 SSD in slot-two.

**NOTE:** There is no thermal pad in slot-two.



1x  
M2x8.5

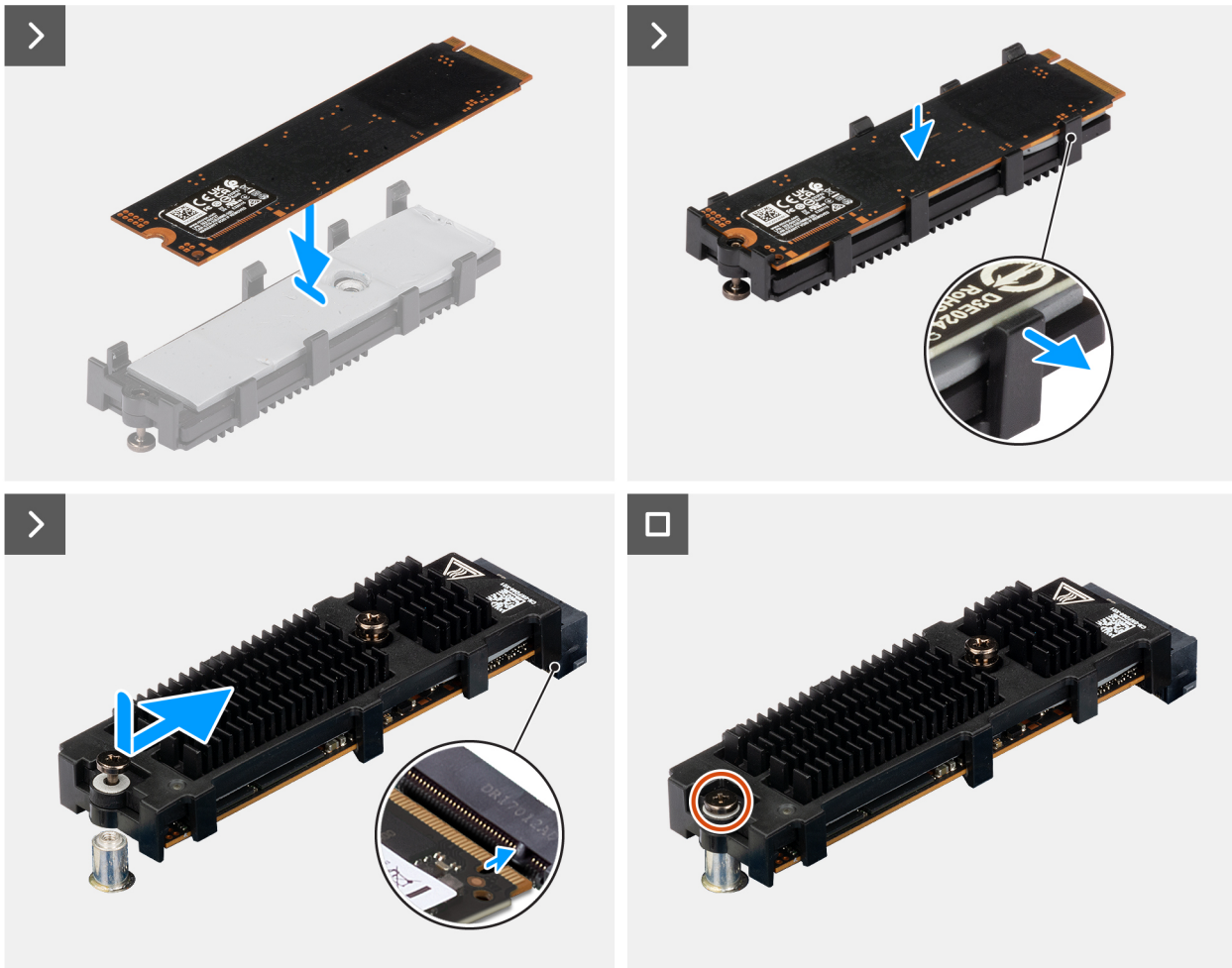
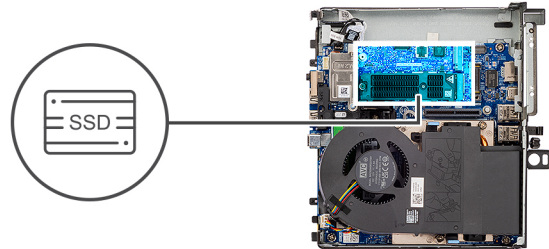

Figure 22. Installing the M.2 2280 PCIe solid state drive (slot-one)

### Steps

1. Place the M.2 2280 SSD on the SSD-extender bracket.
2. Flip over the bracket and align the notch with the tab on the SSD connector on the system board.
3. Insert the SSD-extender bracket at a 45-degree angle into the M.2 connector on the system board.
4. Replace the screw (M2x8.5) that secures the M.2 2280 SSD-extender bracket to the system board.

**NOTE:** Repeat steps 1 to 4 for installing the M.2 2280 SSD in slot-two (if applicable).



### Next steps

1. Install the [riser-card module](#).
2. Install the [side cover](#).
3. Follow the procedure in [after working inside your computer](#).

## Replacing the M.2 2230 SSD with an M.2 2280 SSD

### Prerequisites

1. Follow the procedure in [before working inside your computer](#).
2. Remove the [side cover](#).
3. Remove the [riser-card module](#).

### About this task

The following images provide a visual representation of the procedure to remove the M.2230 and replace it with a M.2 2280 SSD.

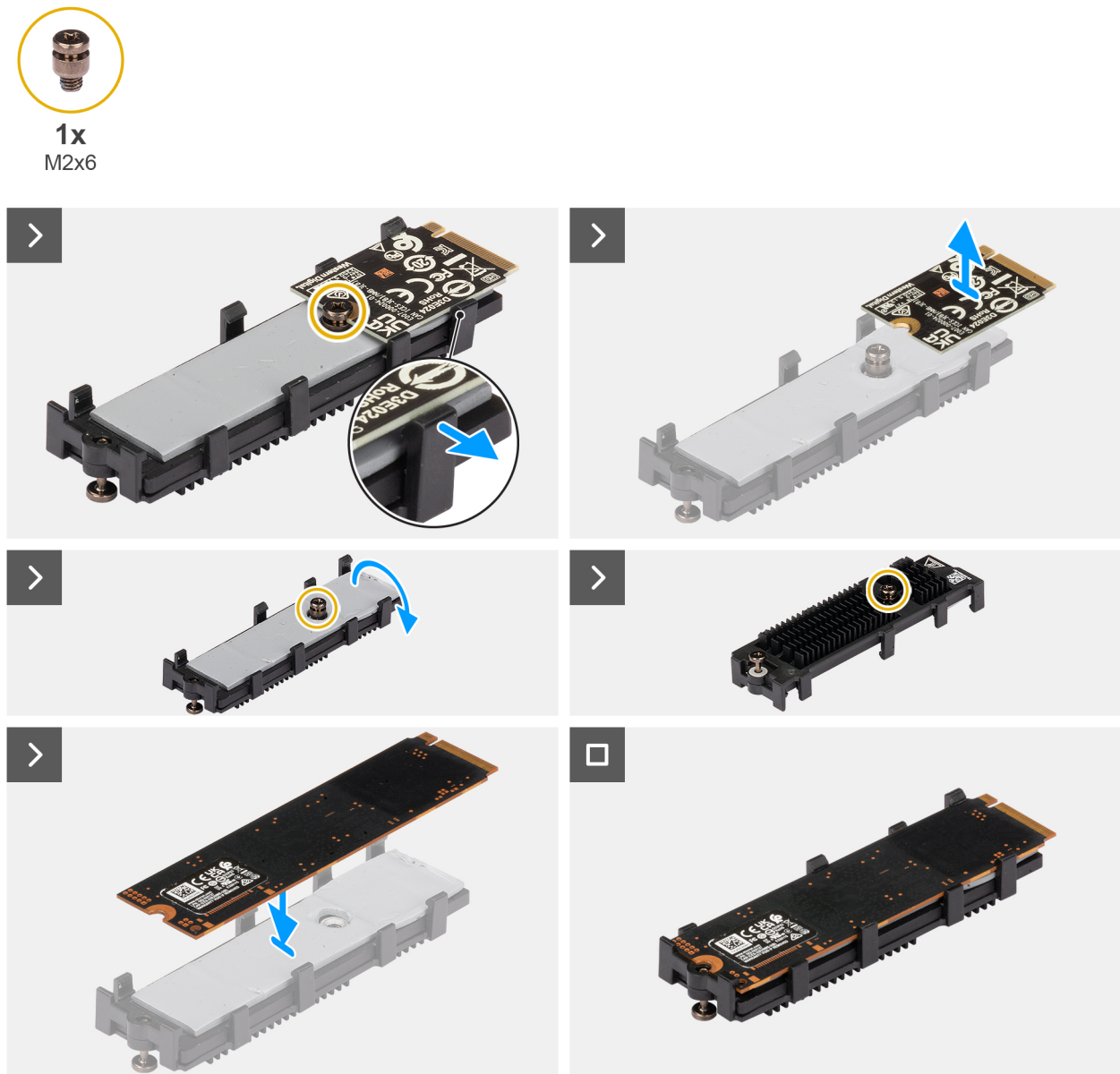

Figure 23. Replacing the M.2 2230 SSD with an M.2 2280 SSD

### Steps

1. Release the four snaps holding the M.2 2230 SSD card.
2. Remove the M.2 2230 SSD from the SSD-extender bracket.
3. Remove the screw (M2x6) to allow placement of the M.2 2280 SSD card on the thermal pad.
4. Flip the SSD-extender bracket and replace the screw (M2x6) on the SSD-extender bracket.
5. Flip back the SSD-extender bracket and place the M.2 2280 solid state drive on the thermal pad of the SSD-extender bracket.
6. Press down the M.2 SSD card until it snaps into place.
7. Install the [M.2 2280 SSD \(slot-1\)](#).

## Replacing the M.2 2280 SSD with an M.2 2230 SSD

### Prerequisites

1. Follow the procedure in [before working inside your computer](#).
2. Remove the [side cover](#).
3. Remove the [riser-card module](#).

### About this task

The following images provide a visual representation of the procedure to remove the M.2280 and replace it with a M.2 2230 SSD.



1x  
M2x6

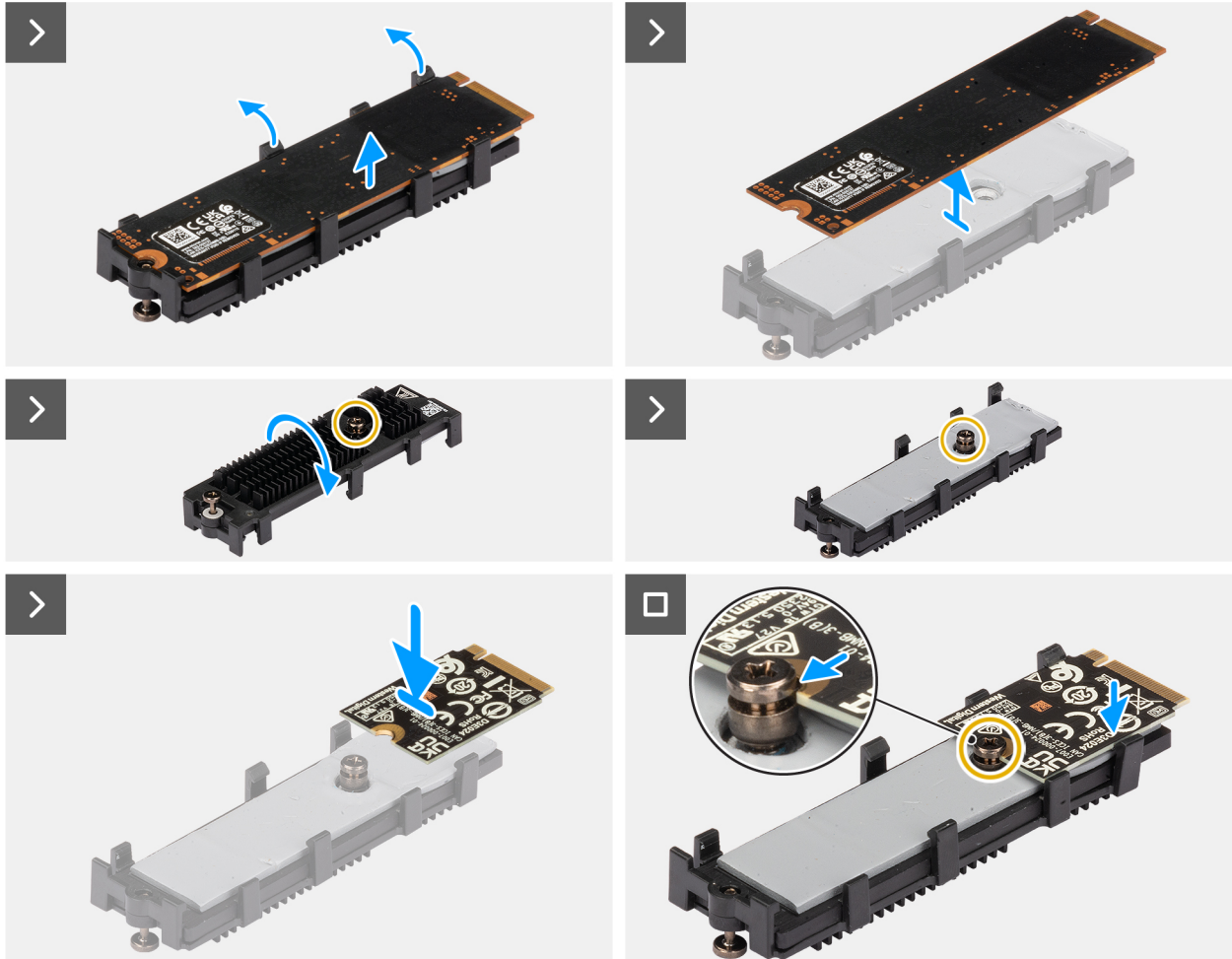

Figure 24. Replacing the M.2 2280 SSD with an M.2 2230 SSD

### Steps

1. Release the snaps holding the M.2 2280 SSD card.
2. Remove the M.2 2280 solid state drive from the SSD-extender bracket.
3. Remove the screw (M2x6) from the SSD-extender bracket.
4. Flip the SSD-extender bracket and replace the screw (M2x6) on the thermal pad.
5. Place the M.2 2230 SSD card on the extender bracket at a 45-degree angle.
6. Align the notch of the card with the screw (M2x6) on the extender bracket.
7. Press down until the M.2 2230 card snaps into place.
8. Install the [M.2 2230 SSD \(slot 1\)](#).

# WLAN card

## Removing the wireless card

### Prerequisites

1. Follow the procedure in [before working inside your computer](#).
2. Remove the [side cover](#).
3. Remove the [riser-card module](#).
4. Remove the [speaker](#).

### About this task

The following image indicates the location of the wireless card and provides a visual representation of the removal procedure.

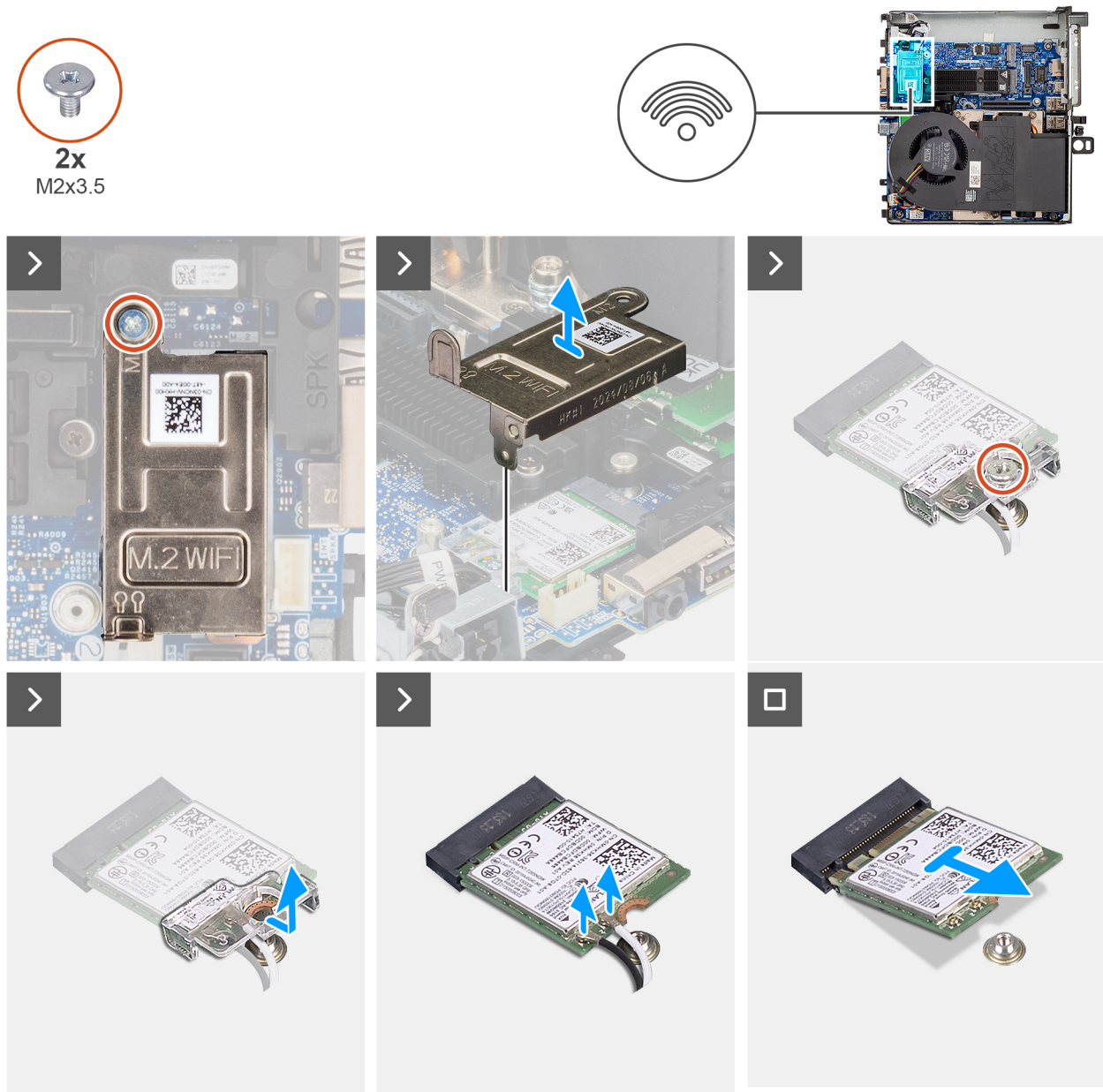

Figure 25. Removing the wireless card

### **Steps**

1. Remove the screw (M2x3.5) that secures the wireless-card shield to the system board.
2. Lift the wireless-card shield out of the computer.
3. Remove the screw (M2x3.5) that secures the wireless-card bracket to the wireless card.
4. Slide and remove the wireless-card bracket off the wireless card.
5. Disconnect the antenna cables from the wireless card.
6. Slide and remove the wireless card from the wireless-card slot.

## **Installing the wireless card**

### **Prerequisites**

If you are replacing a component, remove the existing component before performing the installation procedure.

### **About this task**

The following image indicates the location of the wireless card and provides a visual representation of the installation procedure.



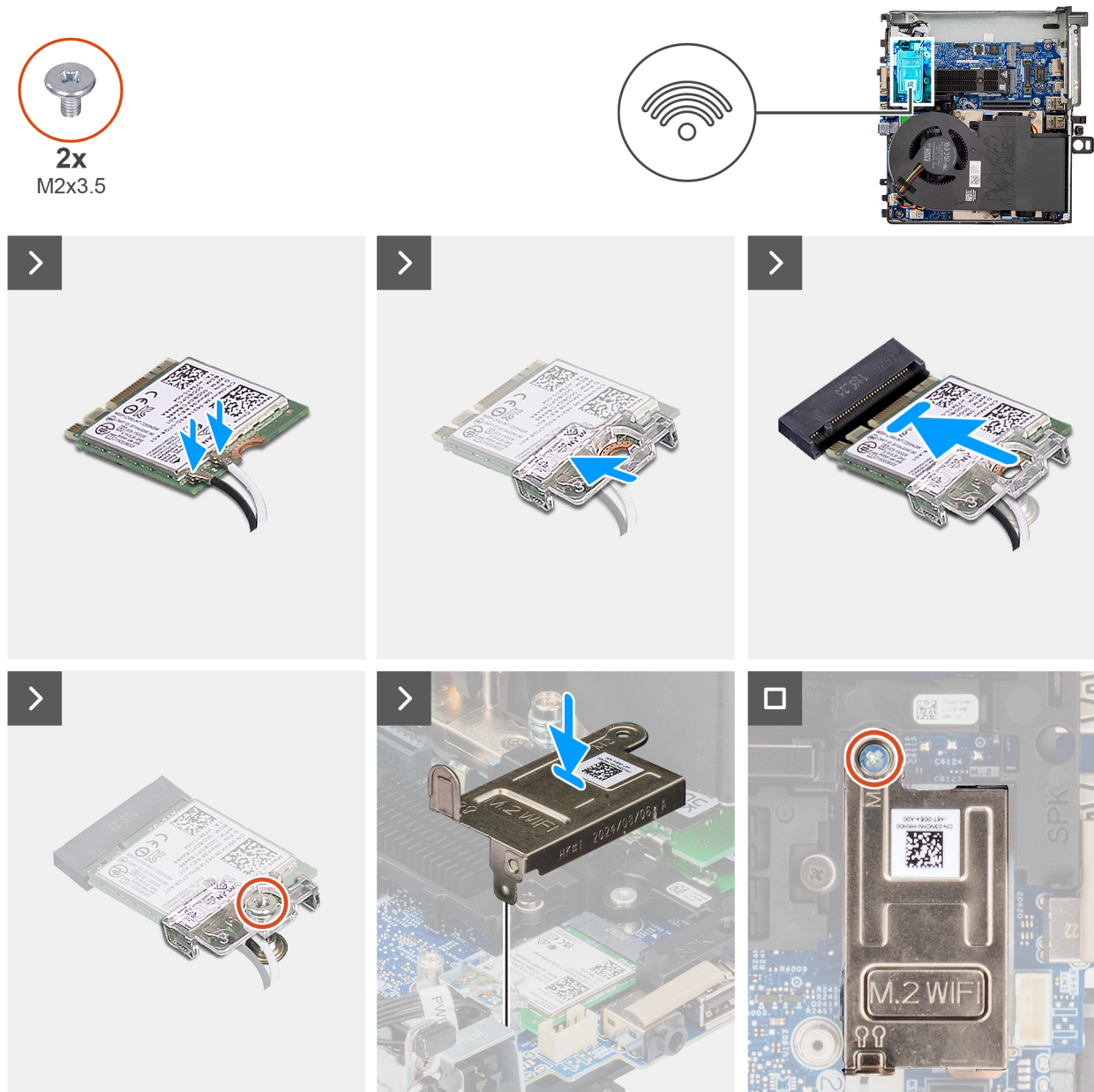

Figure 26. Installing the wireless card

**Steps**

1. Connect the antenna cables to the wireless card.  
The following table provides the antenna-cable color scheme for the WLAN card of your computer.

**Table 24. Antenna-cable color scheme**

Connectors on the wireless card	Antenna-cable color	Silkscreen marking	
Main	White	MAIN	△ (white triangle)
Auxiliary	Black	AUX	▲ (black triangle)

2. Place the wireless-card bracket on the wireless card.
3. Align the notch on the wireless card with the tab on the wireless-card slot.
4. Slide the wireless card at an angle into the wireless-card slot.
5. Replace the screw (M2x3.5) to secure the wireless card and wireless-card bracket to the system board.

6. Align and place the wireless-card shield on the system board and wireless card.
7. Replace the screw (M2x3.5) to secure the wireless-card shield to the system board.

### Next steps

1. Install the [speaker](#).
2. Install the [riser-card module](#).
3. Install the [side cover](#).
4. Follow the procedure in [after working inside your computer](#).

## Speaker

### Removing the speaker

#### Prerequisites

1. Follow the procedure in [before working inside your computer](#).
2. Remove the [side cover](#).
3. Remove the [riser-card module](#).
4. Remove the [system fan](#).

#### About this task

The following image indicates the location of the speaker and provides a visual representation of the removal procedure.

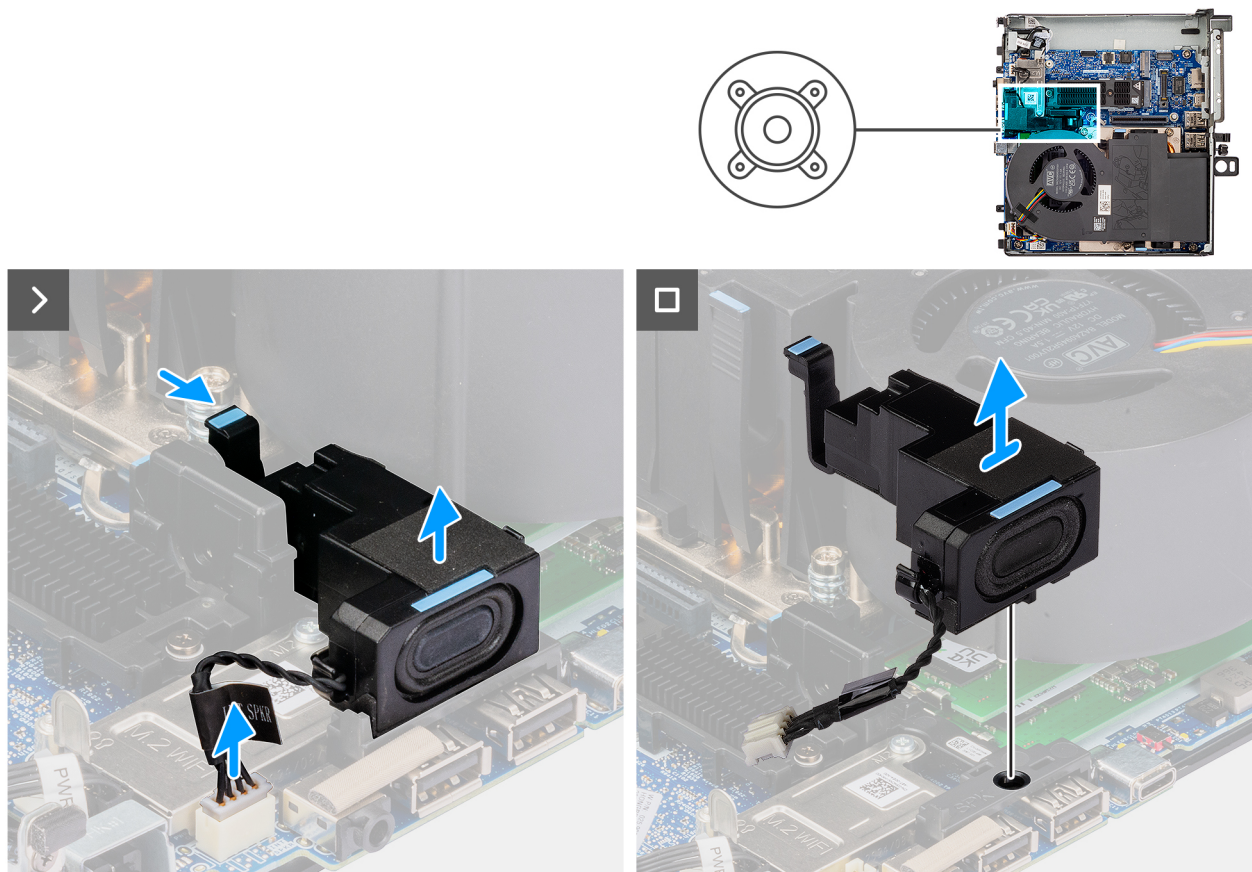

Figure 27. Removing the speaker

#### Steps

1. Disconnect the speaker cable from the connector (INT SPKR) on the system board.

2. Press the release tab and lift the speaker along with the cable from the system board.

## Installing the speaker

### Prerequisites

If you are replacing a component, remove the existing component before performing the installation procedure.

### About this task

The following image indicates the location of the speaker and provides a visual representation of the installation procedure.

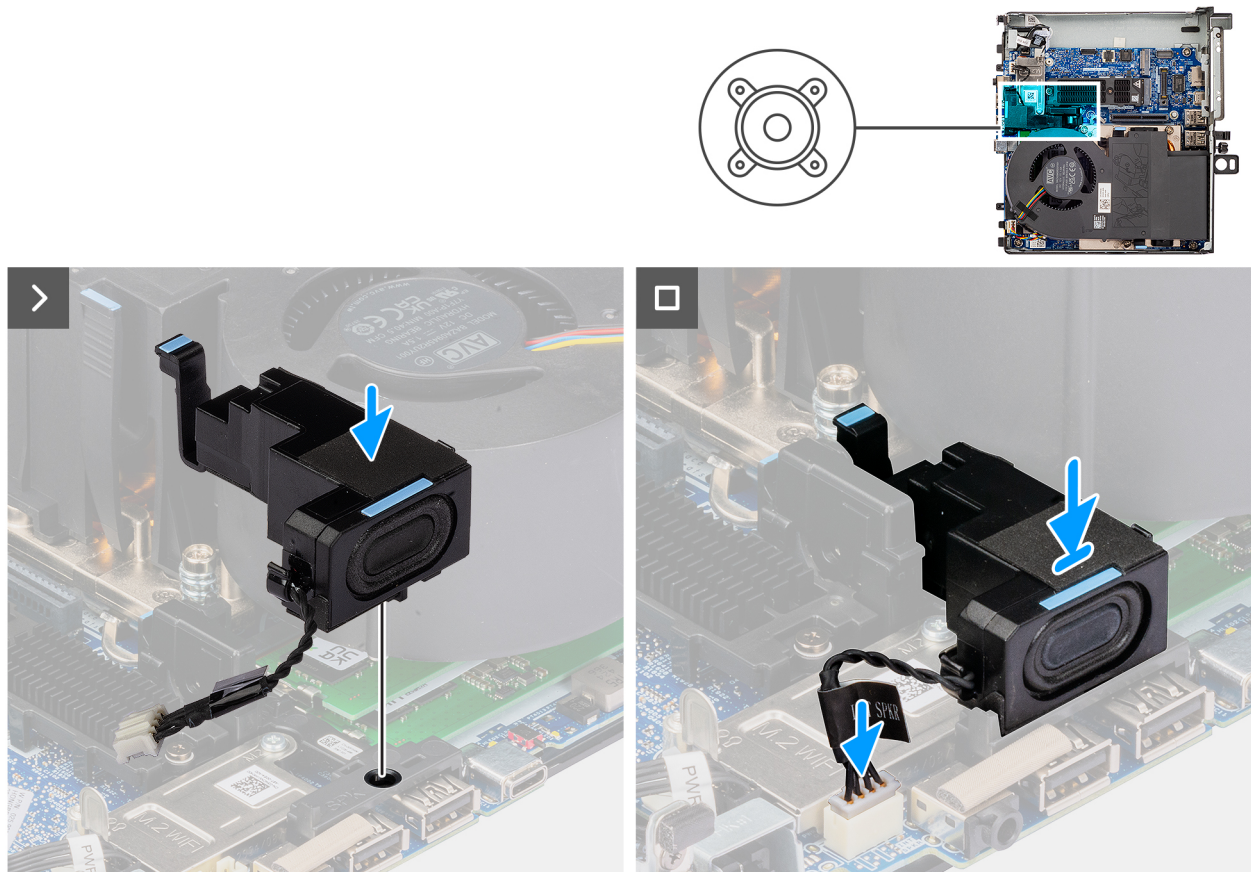

Figure 28. Installing the speaker

### Steps

1. Align and insert the speaker into the slot and press it until the release tab clicks.
2. Connect the speaker cable to the connector (INT SPKR) on the system board.

### Next steps

1. Install the [system fan](#).
2. Install the [riser-card module](#).
3. Install the [side cover](#).
4. Follow the procedure in [after working inside your computer](#).



# Speaker holder

## Removing the speaker holder

### Prerequisites

1. Follow the procedure in [before working inside your computer](#).
2. Remove the [side cover](#).
3. Remove the [riser-card module](#).
4. Remove the [speaker](#).
5. Remove the [wireless card](#).

### About this task

The following image indicates the location of the speaker holder and provides a visual representation of the removal procedure.

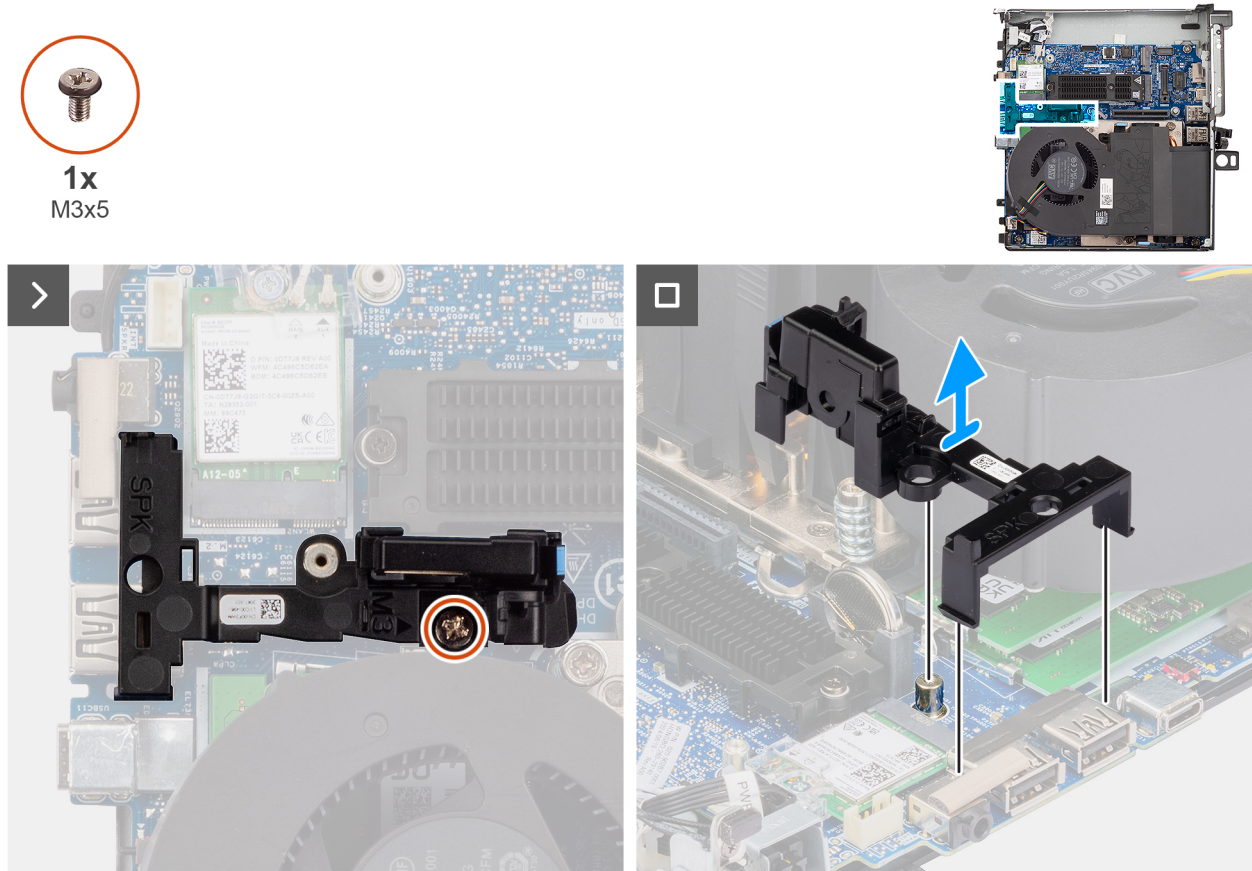

Figure 29. Removing the speaker holder

### Steps

1. Remove the screw (M3x5) that secures the speaker holder to the system board.
2. Lift the speaker holder away from the system board.

## Installing the speaker holder

### Prerequisites

If you are replacing a component, remove the existing component before performing the installation procedure.

### About this task

The following image indicates the location of the speaker holder and provides a visual representation of the installation procedure.

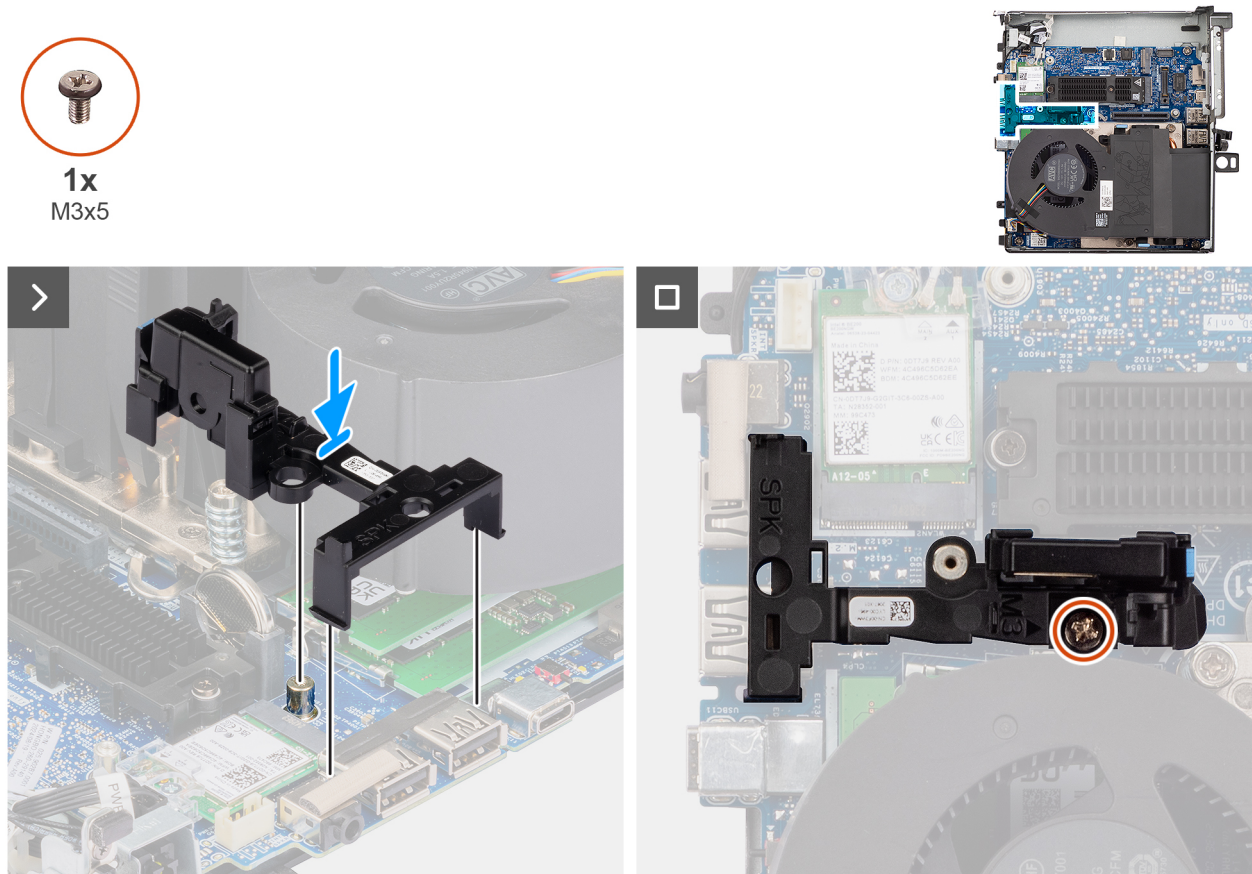

Figure 30. Installing the speaker holder

### Steps

1. Align and insert the speaker holder into the slots on the system board and press it until the release tab clicks.
2. Replace the screw (M3x5) to secure the speaker holder to the system board.

### Next steps

1. Install the [wireless card](#).
2. Install the [speaker](#).
3. Install the [riser-card module](#).
4. Install the [side cover](#).
5. Follow the procedure in [after working inside your computer](#).

## Optional modules

 **NOTE:** The optional modules can be ordered from [Dell.com](https://www.dell.com).

## Installing the 5G optical fiber port

### Prerequisites

If you are replacing a component, remove the existing component before performing the installation procedure.

**About this task**

The following images indicate the location of the optional 5G optical fiber port module and provide a visual representation of the installation procedure.

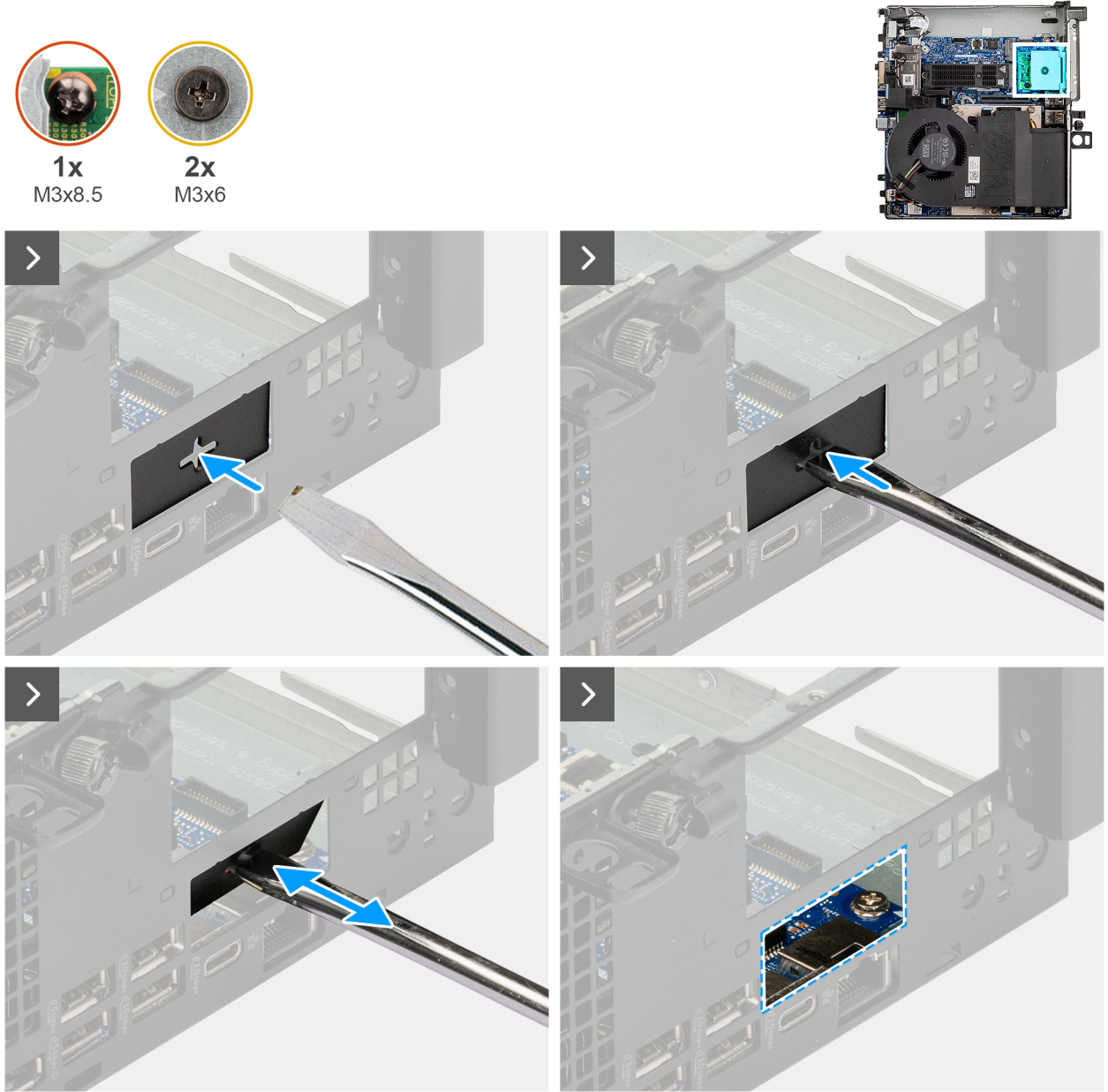

**Figure 31. Installing the 5G optical fiber port**



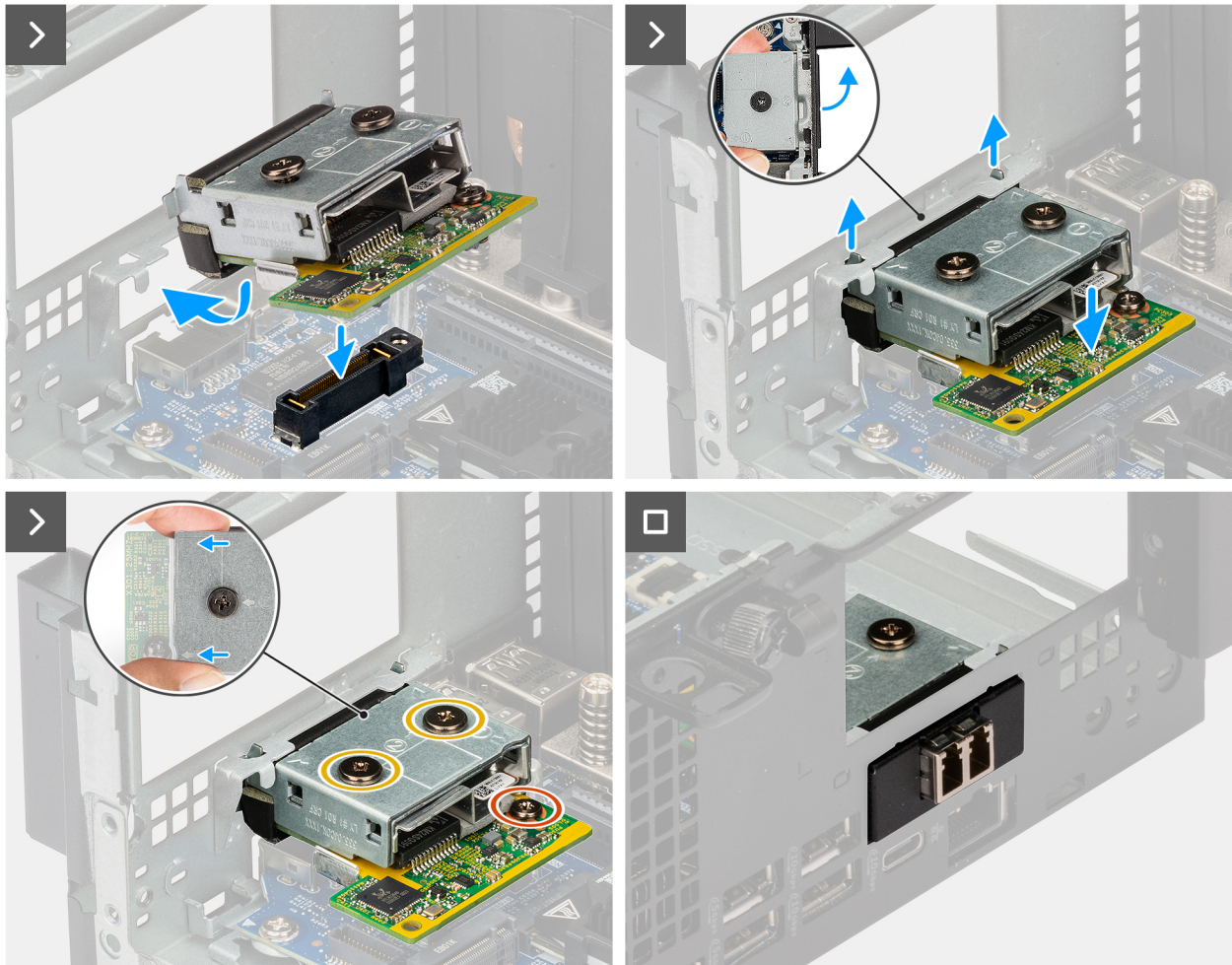

**Figure 32. Installing the 5G optical fiber port**

**Steps**

1. Insert a flat-head screwdriver in the hole of the bracket, push the bracket to release the bracket, and lift the bracket out from the computer.
2. Align and insert the hooks of the optional module port into the slots on the chassis.
3. Gently press the optional module onto the system board until it clicks into place.
4. Tighten the screw (M3x8.5) and two screws (M3x6) to secure the optional module in place.

**Next steps**

1. Install the [riser-card module](#).
2. Install the [side cover](#).
3. Follow the procedure in [after working inside your computer](#).

## Removing the 5G optical fiber port

**Prerequisites**

1. Follow the procedure in [before working inside your computer](#).
2. Remove the [side cover](#).
3. Remove the [riser-card module](#).

**About this task**

The following images indicate the location of the optional 5G optical fiber port module and provide a visual representation of the removal procedure.

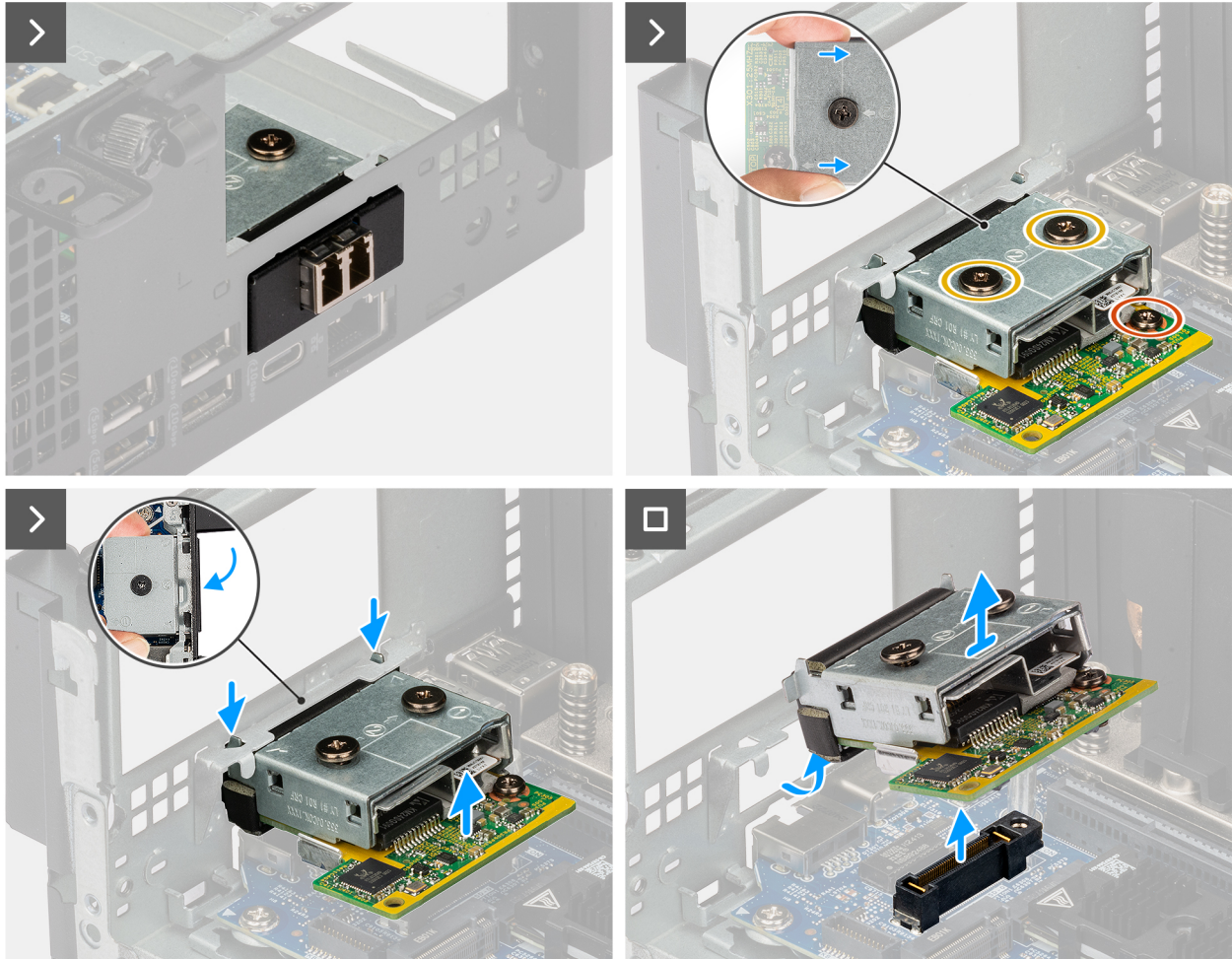
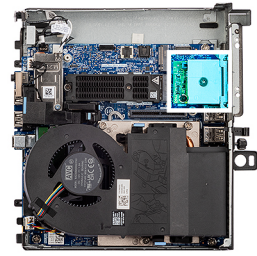

**Figure 33. Removing the 5G optical fiber port**

**Steps**

1. Remove the screw (M3x8.5) and loosen the two screws (M3x6) that secure the optional module in place.
2. Lift the optional module at an angle and unhook from the chassis.

## Installing the PS2 port

**Prerequisites**

If you are replacing a component, remove the existing component before performing the installation procedure.

**About this task**

The following images indicate the location of the optional PS2 port module and provide a visual representation of the installation procedure.





1x  
M3x8.5



1x  
M3x6

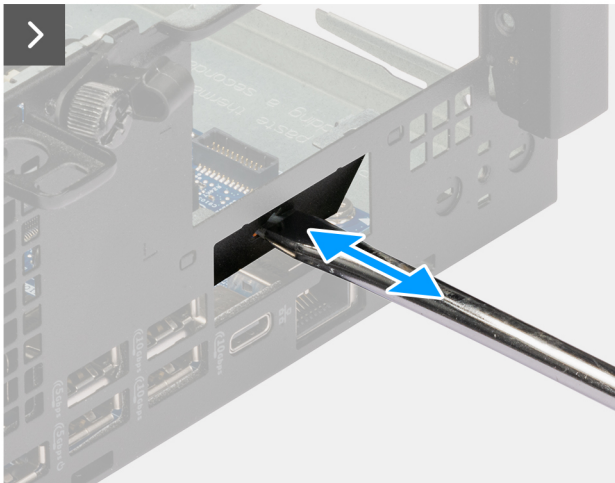
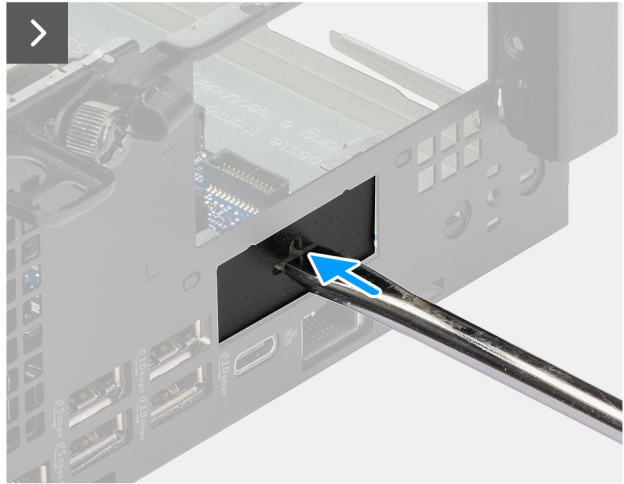
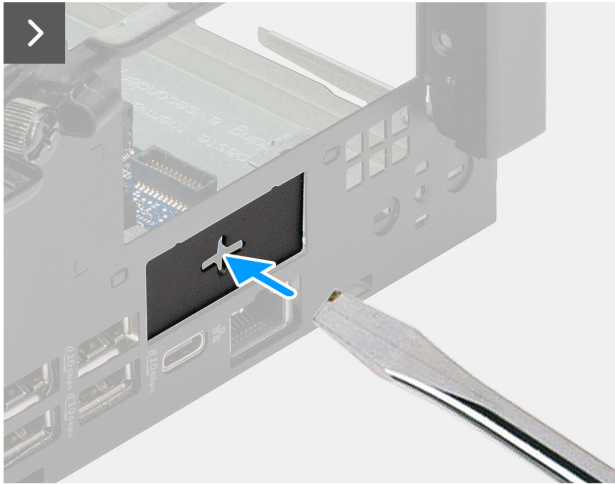
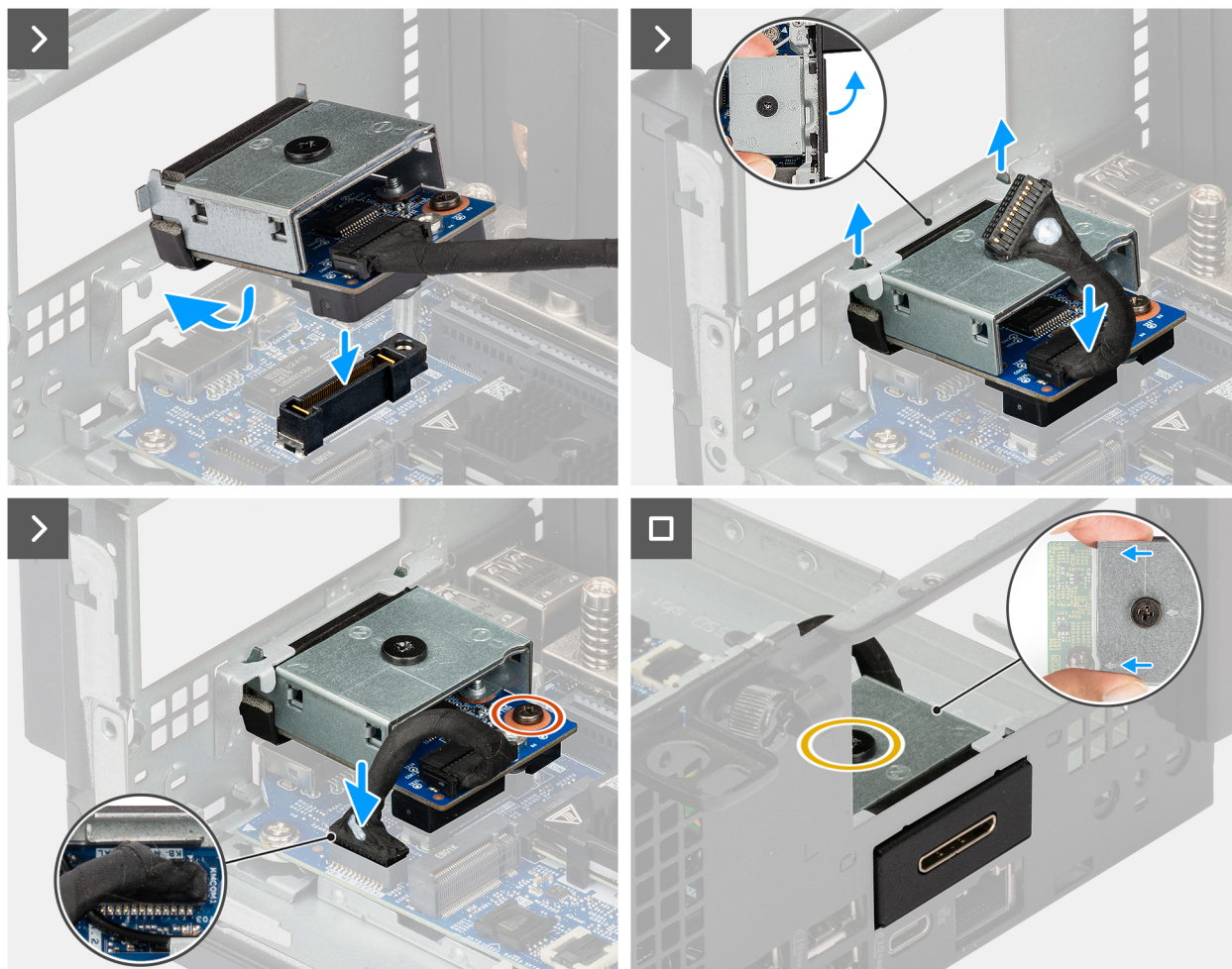

Figure 34. Installing the PS2 port





**Figure 35. Installing the PS2 port**

### Steps

1. Insert a flat-head screwdriver in the hole of the bracket, push the bracket to release the bracket, and lift the bracket out from the computer.
2. Align and insert the hooks of the optional module port into the slots on the chassis.
3. Gently press the optional module onto the system board until it clicks into place.
4. Tighten the screw (M3x8.5) and screw (M3x6) to secure the optional module in place.
5. Connect the PS2 cable to its connector (OPTION) on the system board.

### Next steps

1. Install the [riser-card module](#).
2. Install the [side cover](#).
3. Follow the procedure in [after working inside your computer](#).

## Removing the PS2 port

### Prerequisites

1. Follow the procedure in [before working inside your computer](#).
2. Remove the [side cover](#).
3. Remove the [riser-card module](#).

### About this task

The following images indicate the location of the optional PS2 port module and provide a visual representation of the removal procedure.

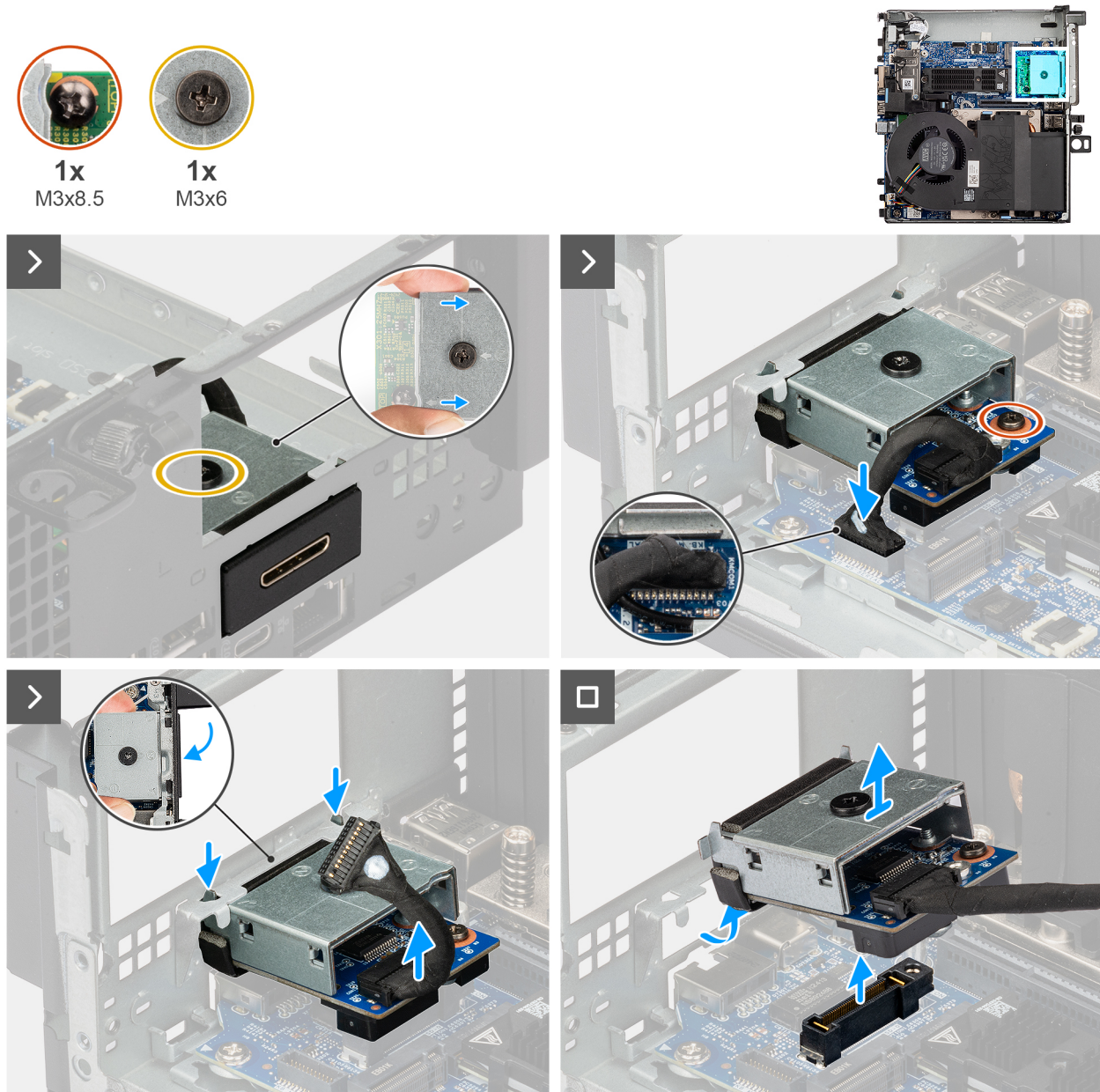

Figure 36. Removing the PS2 port

### Steps

1. Disconnect the PS2 cable from its connector (OPTION) on the system board.
2. Remove the screw (M3x8.5) and loosen the screw (M3x6) that secure the optional module in place.
3. Lift the optional module at an angle and unhook from the chassis.

## Installing the DisplayPort

### Prerequisites

If you are replacing a component, remove the existing component before performing the installation procedure.



**About this task**

The following images indicate the location of the optional DisplayPort module and provide a visual representation of the installation procedure.

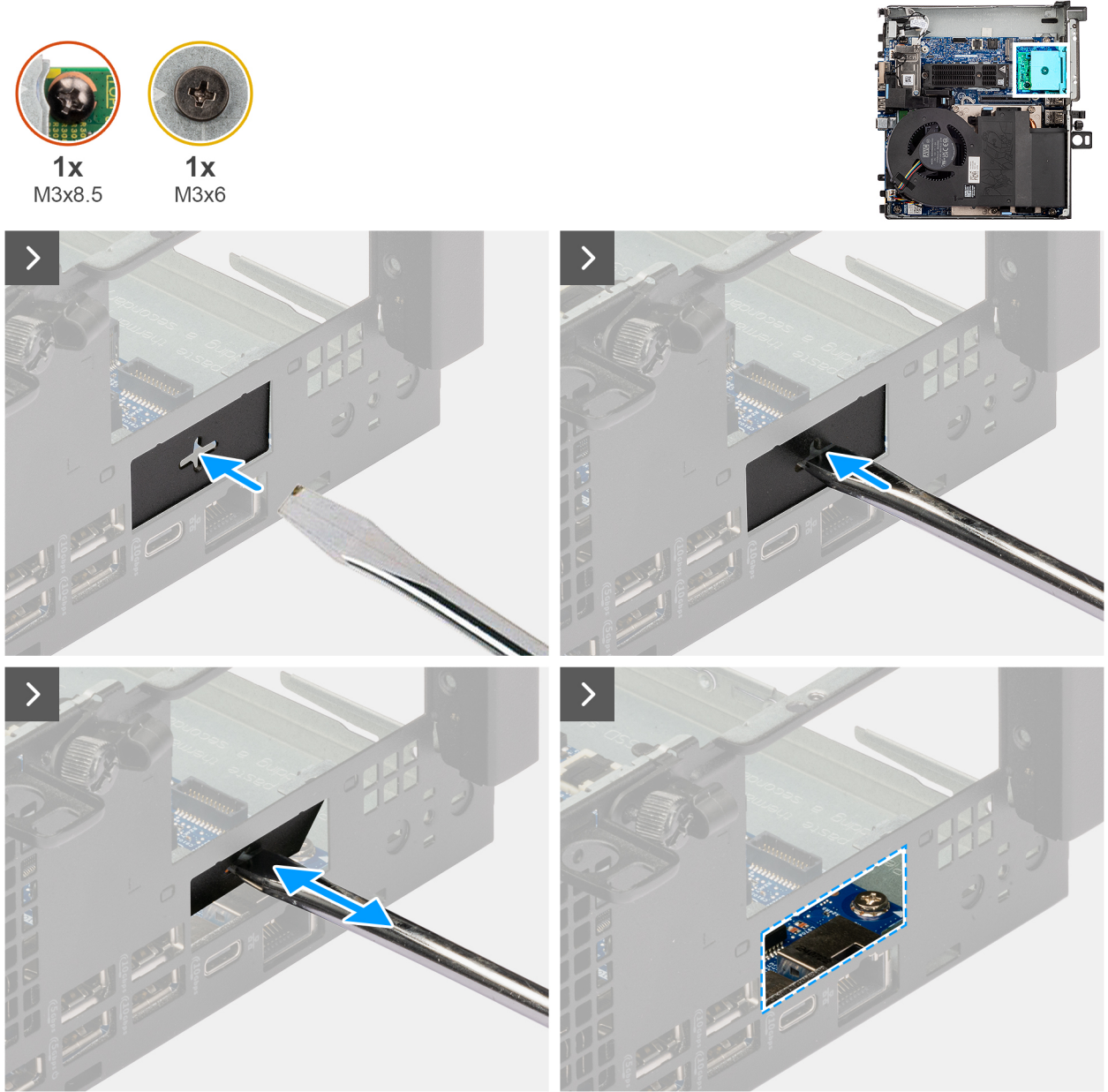

**Figure 37. Installing the DisplayPort**

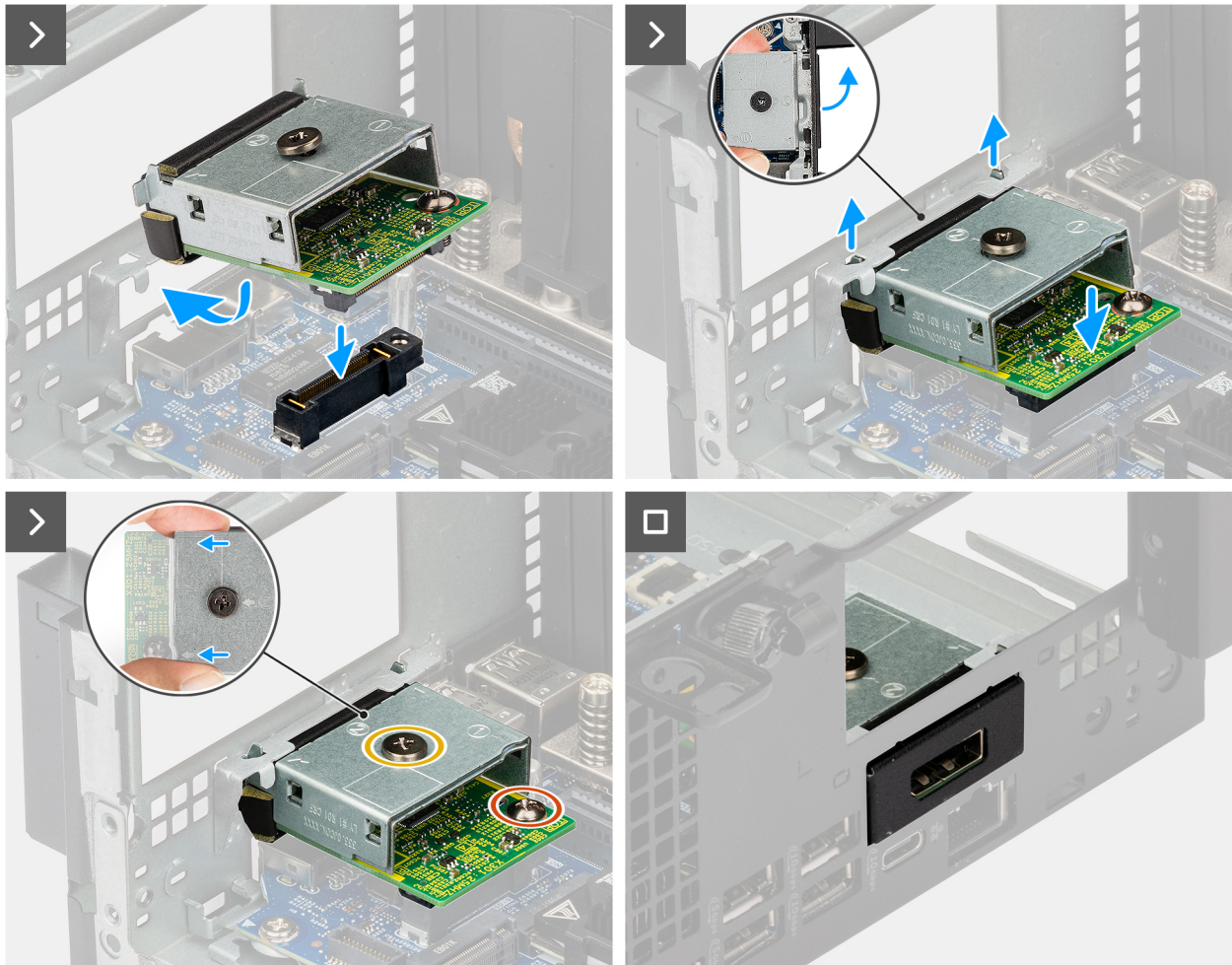

**Figure 38. Installing the DisplayPort**

**Steps**

1. Insert a flat-head screwdriver in the hole of the bracket, push the bracket to release the bracket, and lift the bracket out from the computer.
2. Align and insert the hooks of the optional module port into the slots on the chassis.
3. Gently press the optional module onto the system board until it clicks into place.
4. Tighten the screw (M3x8.5) and screw (M3x6) to secure the optional module in place.

**Next steps**

1. Install the [riser-card module](#).
2. Install the [side cover](#).
3. Follow the procedure in [after working inside your computer](#).

## Removing the DisplayPort

**Prerequisites**

1. Follow the procedure in [before working inside your computer](#).
2. Remove the [side cover](#).
3. Remove the [riser-card module](#).

**About this task**

The following images indicate the location of the optional DisplayPort module and provide a visual representation of the removal procedure.





1x  
M3x8.5



1x  
M3x6

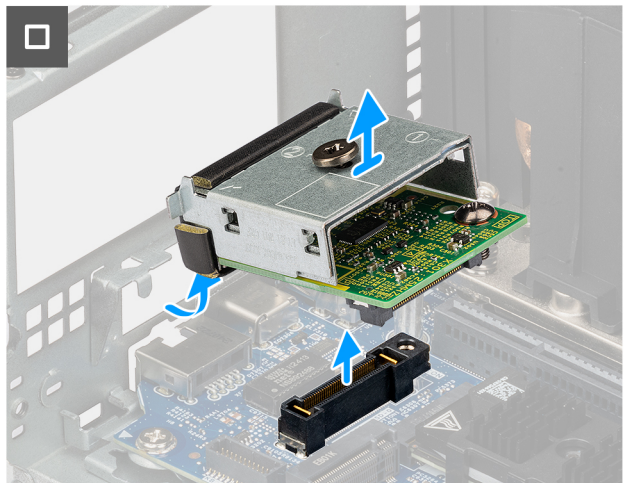
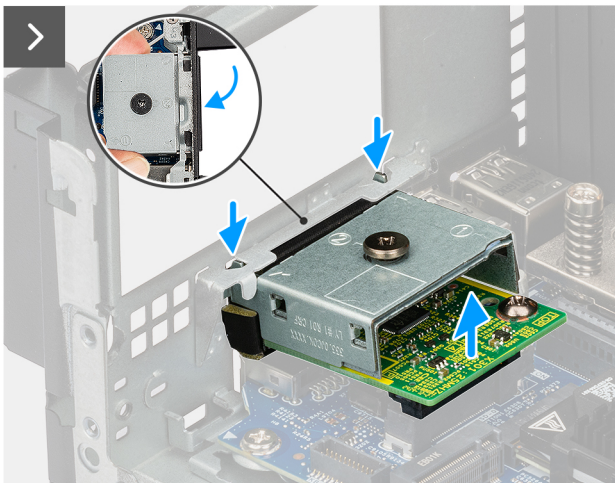
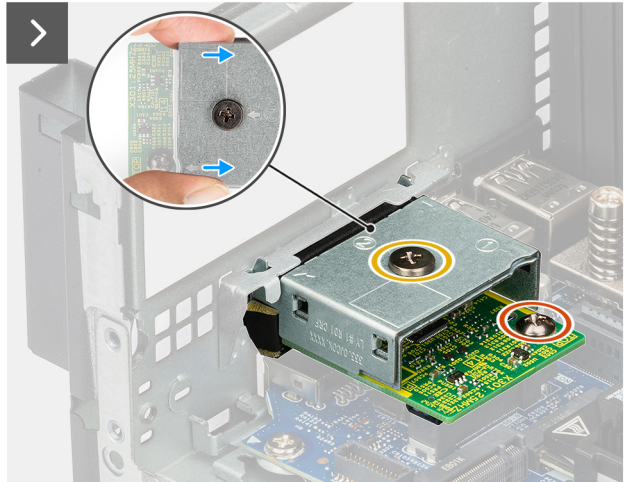
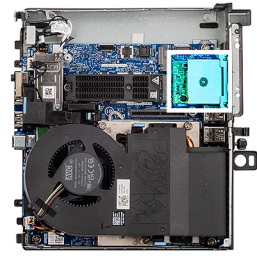

**Figure 39. Removing the DisplayPort**

### Steps

1. Remove the screw (M3x8.5) and loosen the screw (M3x6) that secure the optional module in place.
2. Lift the optional module at an angle and unhook from the chassis.

## Installing the Thunderbolt port

### Prerequisites

If you are replacing a component, remove the existing component before performing the installation procedure.

### About this task

The following images indicate the location of the optional Thunderbolt port module and provide a visual representation of the installation procedure.



1x  
M3x8.5



1x  
M3x6

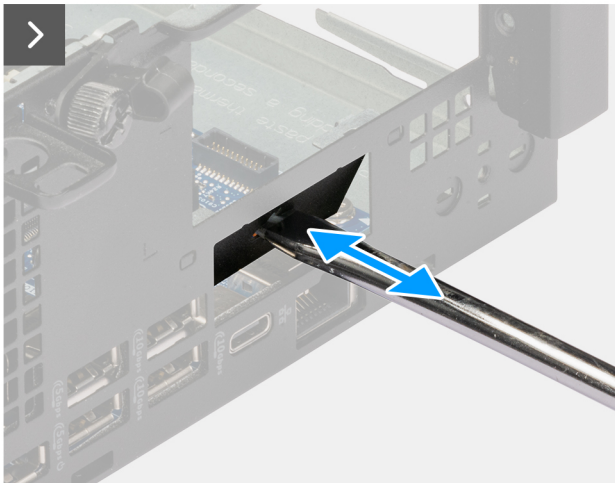
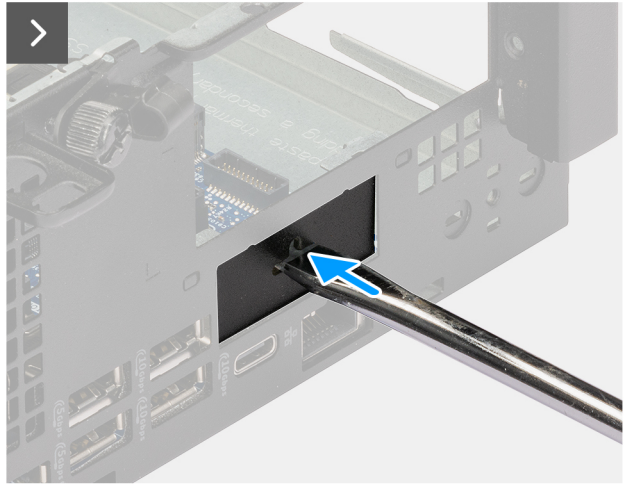
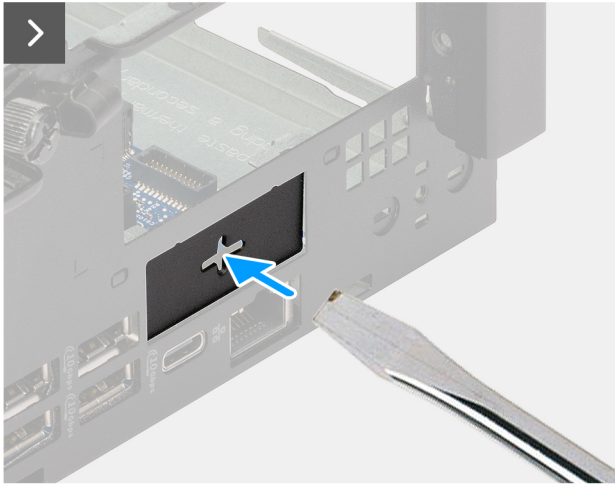
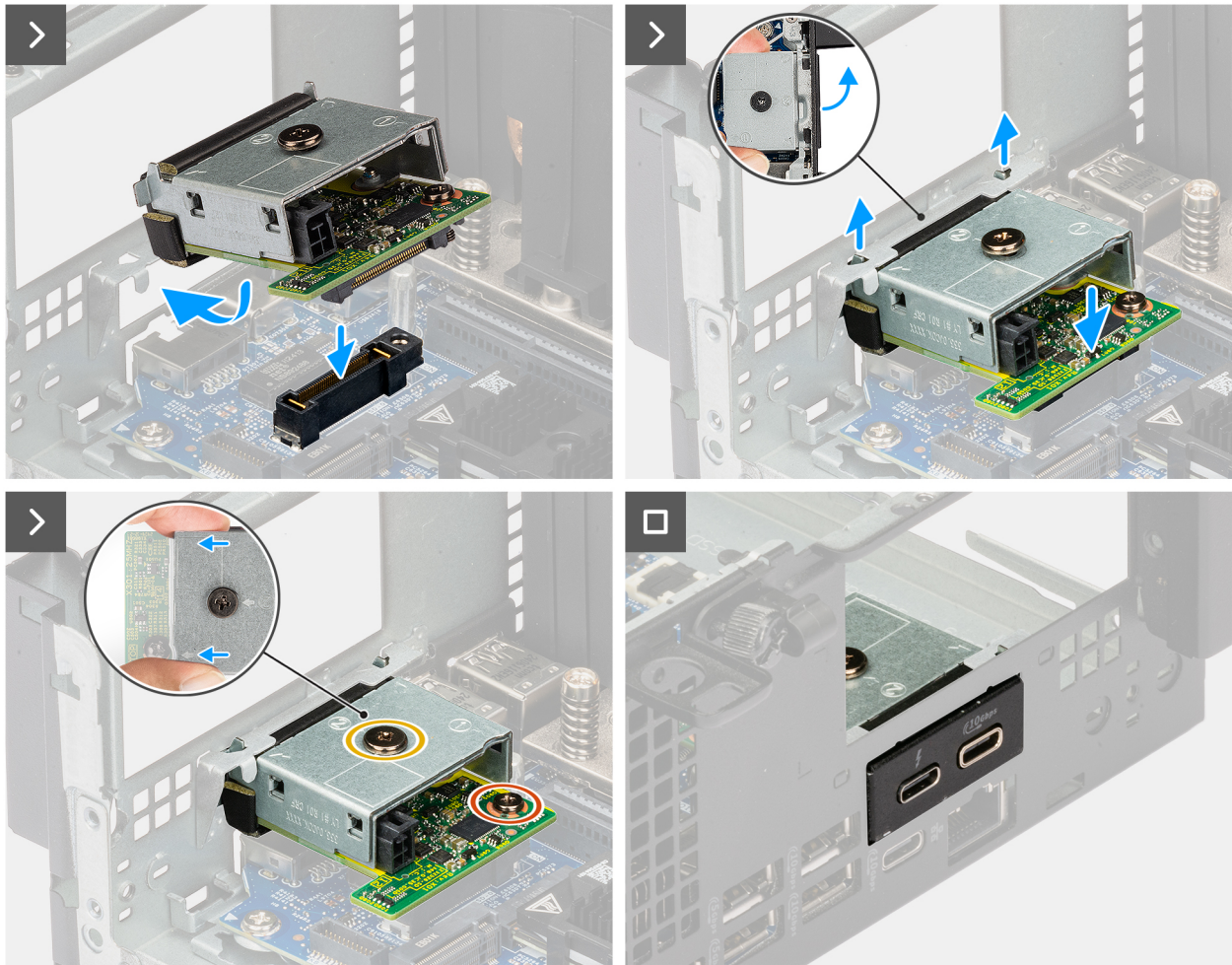

Figure 40. Installing the Thunderbolt port





**Figure 41. Installing the Thunderbolt port**

**Steps**

1. Insert a flat-head screwdriver in the hole of the bracket, push the bracket to release the bracket, and lift the bracket out from the computer.
2. Align and insert the hooks of the optional module port into the slots on the chassis.
3. Gently press the optional module onto the system board until it clicks into place.
4. Tighten the screw (M3x8.5) and screw (M3x6) to secure the optional module in place.

**Next steps**

1. Install the [riser-card module](#).
2. Install the [side cover](#).
3. Follow the procedure in [after working inside your computer](#).

## Removing the Thunderbolt port

**Prerequisites**

1. Follow the procedure in [before working inside your computer](#).
2. Remove the [side cover](#).
3. Remove the [riser-card module](#).

**About this task**

The following images indicate the location of the optional Thunderbolt port module and provide a visual representation of the removal procedure.



1x  
M3x8.5



1x  
M3x6

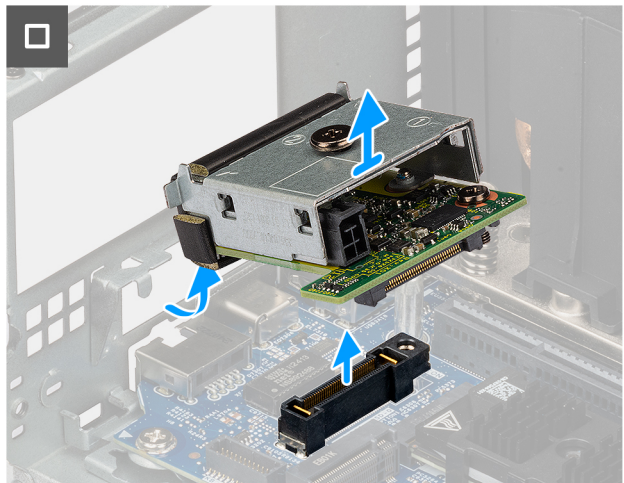
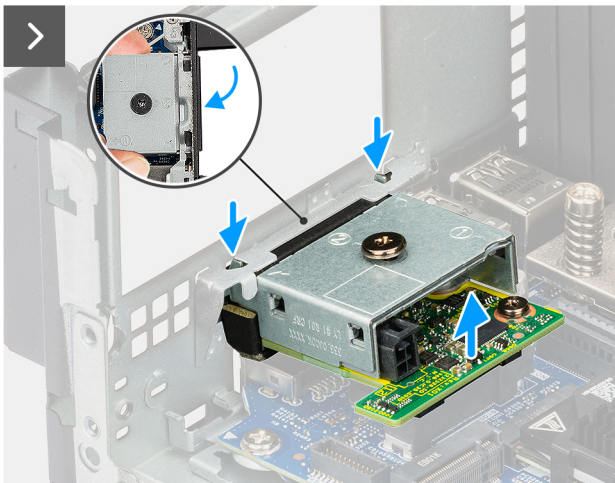
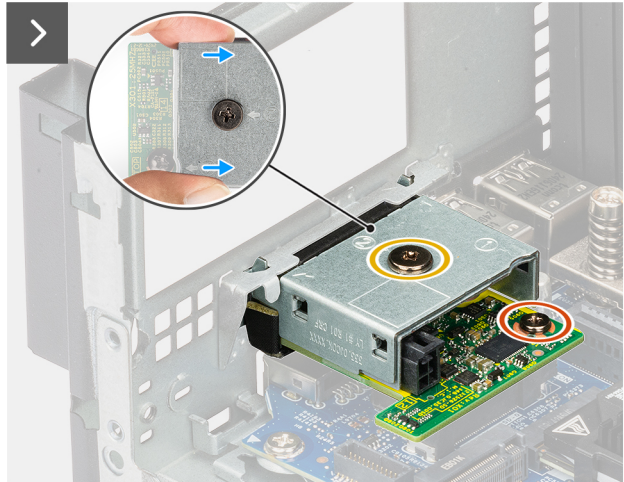
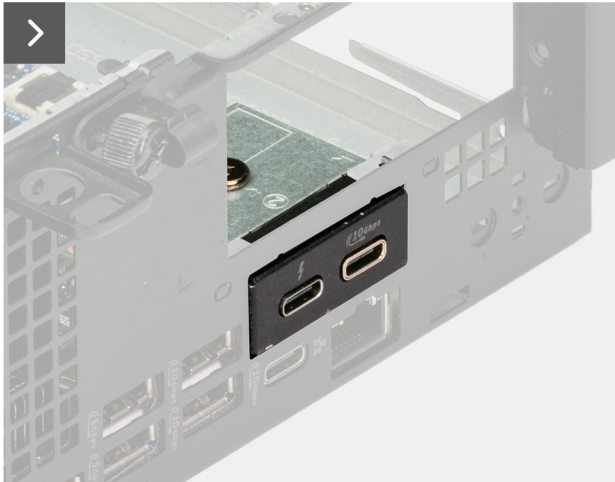

Figure 42. Removing the Thunderbolt port

### Steps

1. Remove the screw (M3x8.5) and loosen the screw (M3x6) that secure the optional module in place.
2. Lift the optional module at an angle and unhook from the chassis.

## Installing the HDMI port

### Prerequisites

If you are replacing a component, remove the existing component before performing the installation procedure.

### About this task

The following images indicate the location of the optional HDMI port module and provide a visual representation of the installation procedure.





1x  
M3x8.5



1x  
M3x6

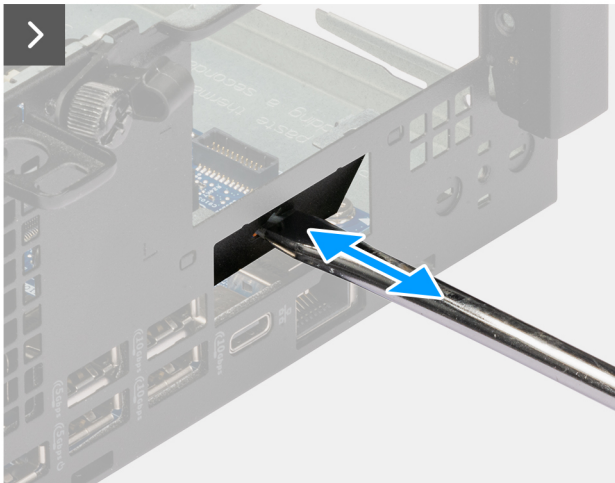
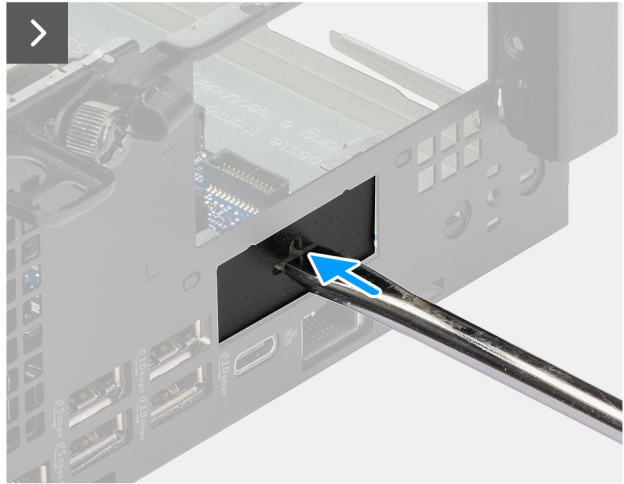
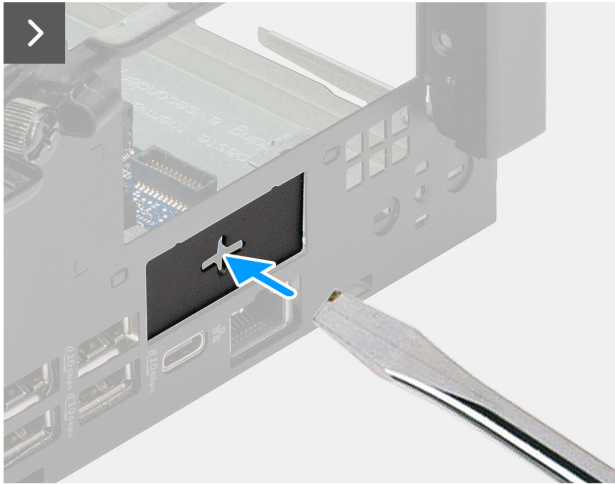
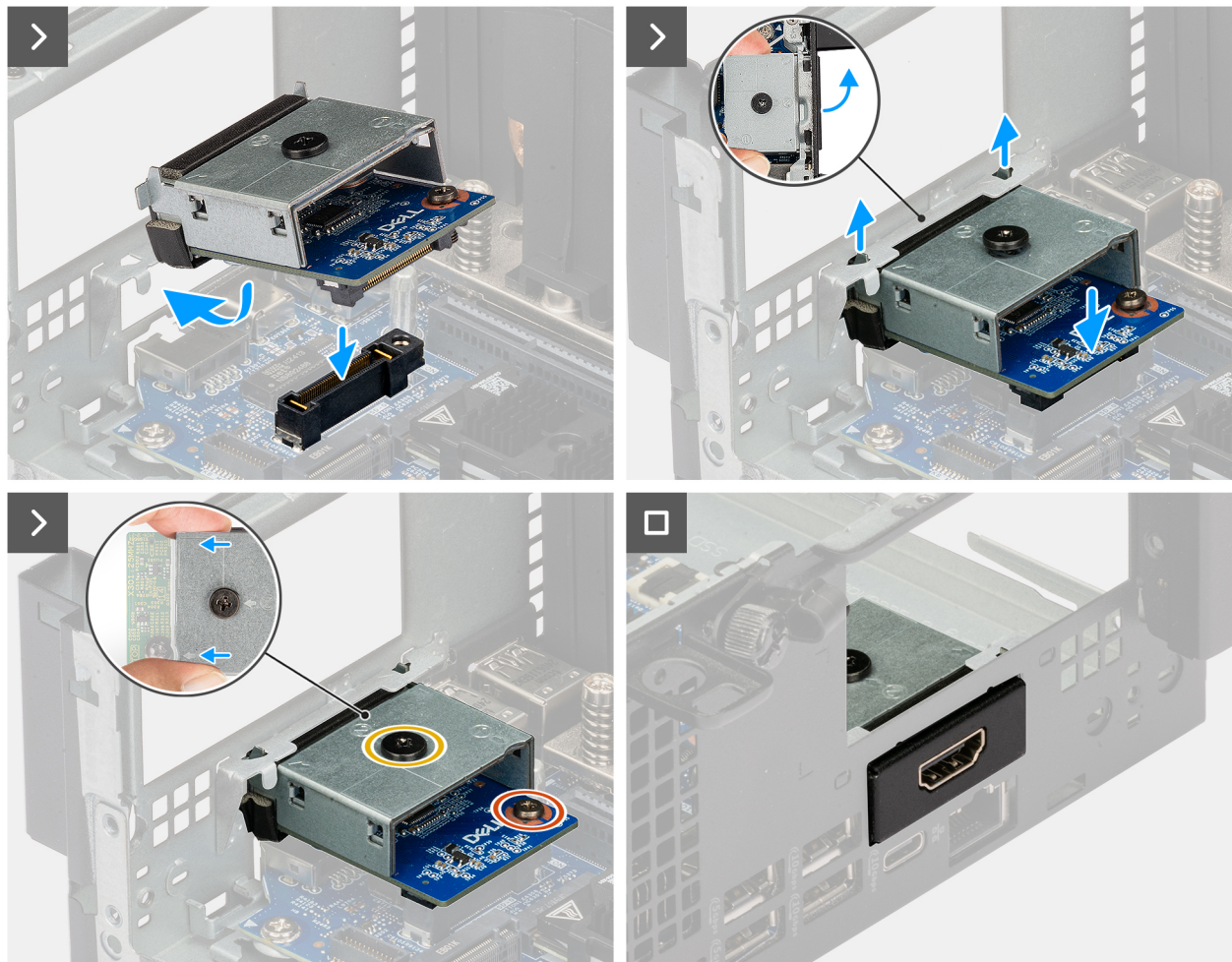

Figure 43. Installing the HDMI port



**Figure 44. Installing the HDMI port**

**Steps**

1. Insert a flat-head screwdriver in the hole of the bracket, push the bracket to release the bracket, and lift the bracket out from the computer.
2. Align and insert the hooks of the optional module port into the slots on the chassis.
3. Gently press the optional module onto the system board until it clicks into place.
4. Tighten the screw (M3x8.5) and screw (M3x6) to secure the optional module in place.

**Next steps**

1. Install the [riser-card module](#).
2. Install the [side cover](#).
3. Follow the procedure in [after working inside your computer](#).

## Removing the HDMI port

**Prerequisites**

1. Follow the procedure in [before working inside your computer](#).
2. Remove the [side cover](#).
3. Remove the [riser-card module](#).

**About this task**

The following images indicate the location of the optional HDMI port module and provide a visual representation of the removal procedure.





1x  
M3x8.5



1x  
M3x6

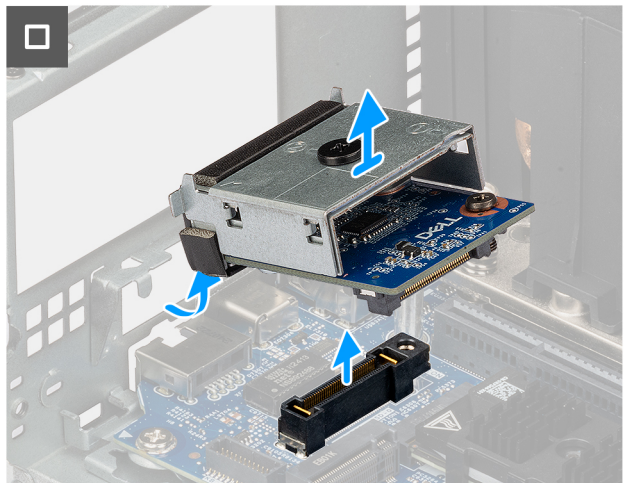
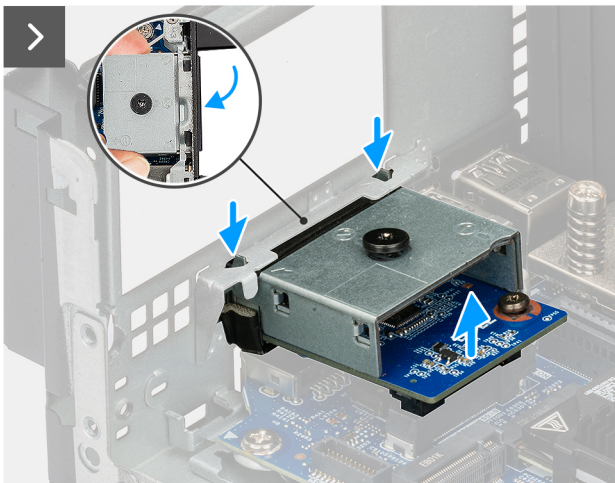
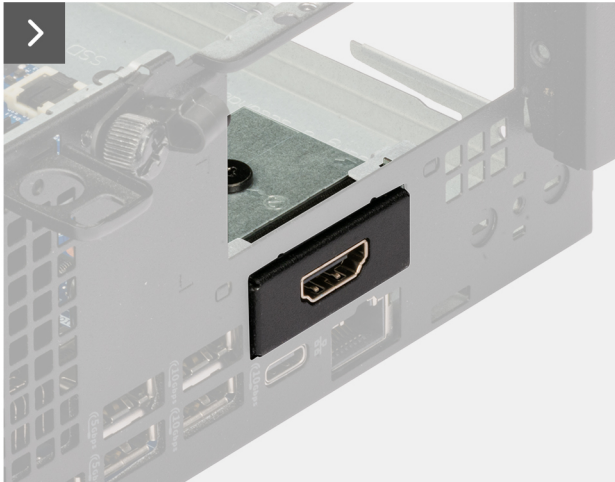

**Figure 45. Removing the HDMI port**

**Steps**

1. Remove the screw (M3x8.5) and loosen the screw (M3x6) that secure the optional module in place.
2. Lift the optional module at an angle and unhook from the chassis.

# Removing and installing Field Replaceable Units (FRUs)

The replaceable components in this chapter are Field Replaceable Units (FRUs).

**CAUTION:** The information in this removing and installing FRUs section is intended for authorized service technicians only.

**CAUTION:** To avoid any potential damage to the component or loss of data, Dell Technologies recommends that an authorized service technician replaces the Field Replaceable Units (FRUs).

**CAUTION:** Your warranty does not cover damages that may occur during FRU repairs that are not authorized by Dell Technologies.

**NOTE:** The images in this document may differ from your computer depending on the configuration you ordered.

## Heat sink

### Removing the heat sink

#### Prerequisites

1. Follow the procedure in [before working inside your computer](#).
2. Remove the [side cover](#).
3. Remove the [riser-card module](#).
4. Remove the [system fan](#).

#### About this task

- NOTE:** The heat sink may become hot during normal operation. Allow sufficient time for the heat sink to cool before you touch it.
- NOTE:** For maximum cooling of the processor, do not touch the heat-transfer areas on the heat sink. The oils in your skin can reduce the heat-transfer capability of the thermal grease.

The following images indicate the location of the heat sink and provide a visual representation of the removal procedure.



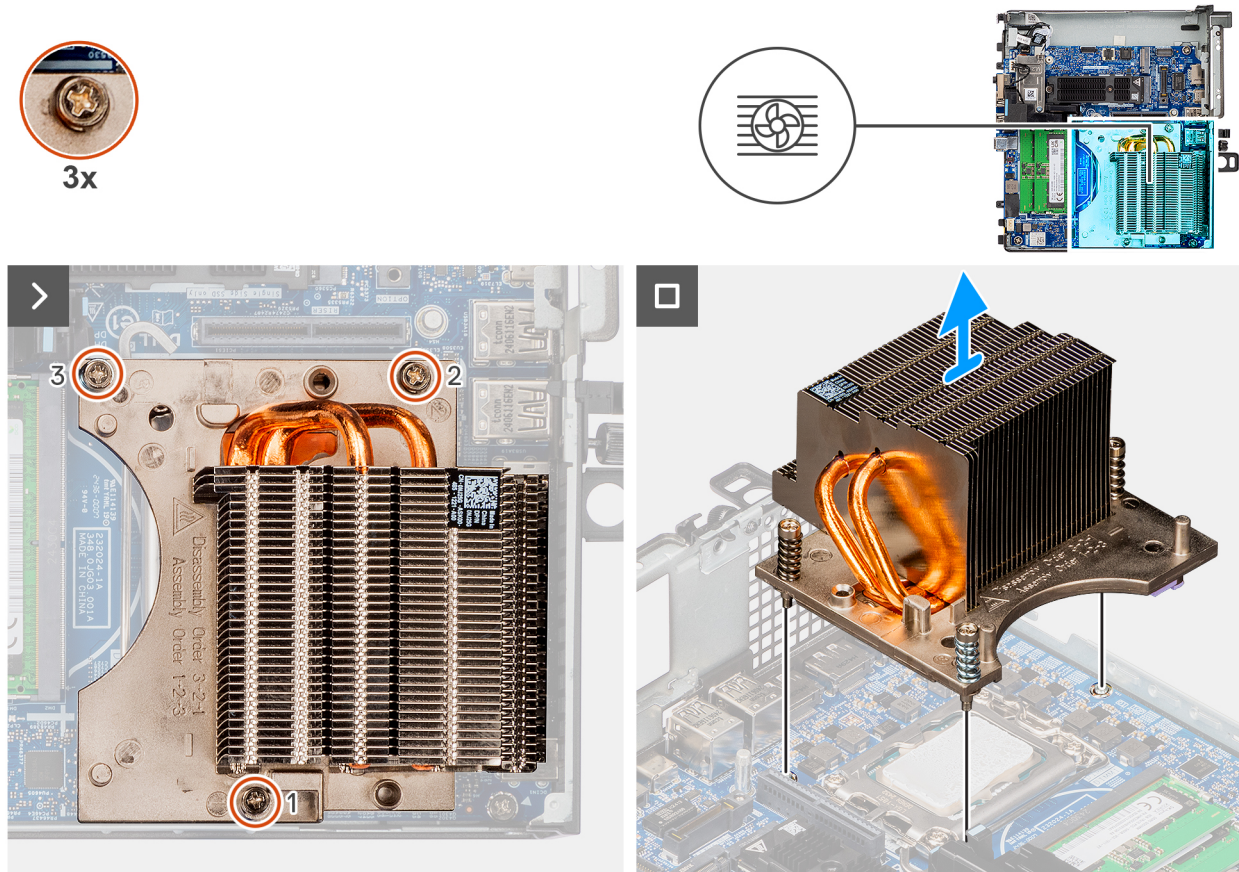

**Figure 46. Removing the heat sink**

**Steps**

1. In sequential order (3 > 2 > 1), loosen the three captive screws that secure the heat sink to the computer.
2. Lift the heat sink from the system board.

## Installing the heat sink

**Prerequisites**

If you are replacing a component, remove the existing component before performing the installation procedure.

**About this task**

**NOTE:** If either the processor or the fan and heat-sink assembly is replaced, use the thermal grease that is provided in the kit to ensure that thermal conductivity is achieved.

The following image indicates the location of the heat sink and provides a visual representation of the installation procedure.



3x

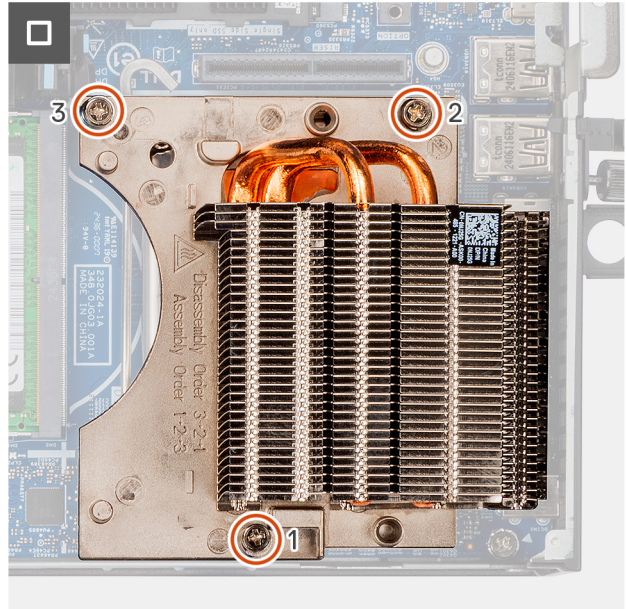
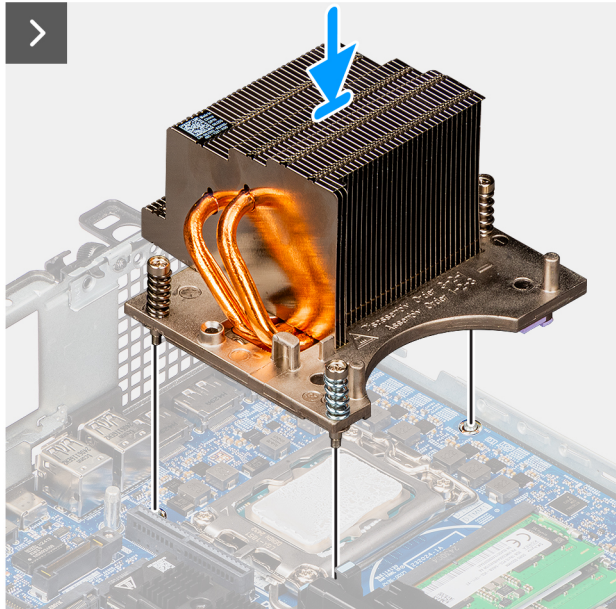
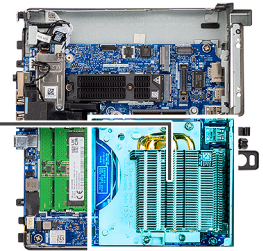

Figure 47. Installing the heat sink

### Steps

1. Align the screw holes on the heat sink with the screw holes on the system board.
2. Tighten the three captive screws in a sequential order (1->2->3) to secure the heat sink to the system board.

### Next steps

1. Install the [system fan](#).
2. Install the [riser-card module](#).
3. Install the [side cover](#).
4. Follow the procedure in [after working inside your computer](#).

## Processor

### Removing the processor

#### Prerequisites

1. Follow the procedure in [before working inside your computer](#).
2. Remove the [side cover](#).
3. Remove the [riser-card module](#).
4. Remove the [system fan](#).
5. Remove the [heat sink](#).

#### About this task

The following images indicate the location of the processor and provide a visual representation of the removal procedure.

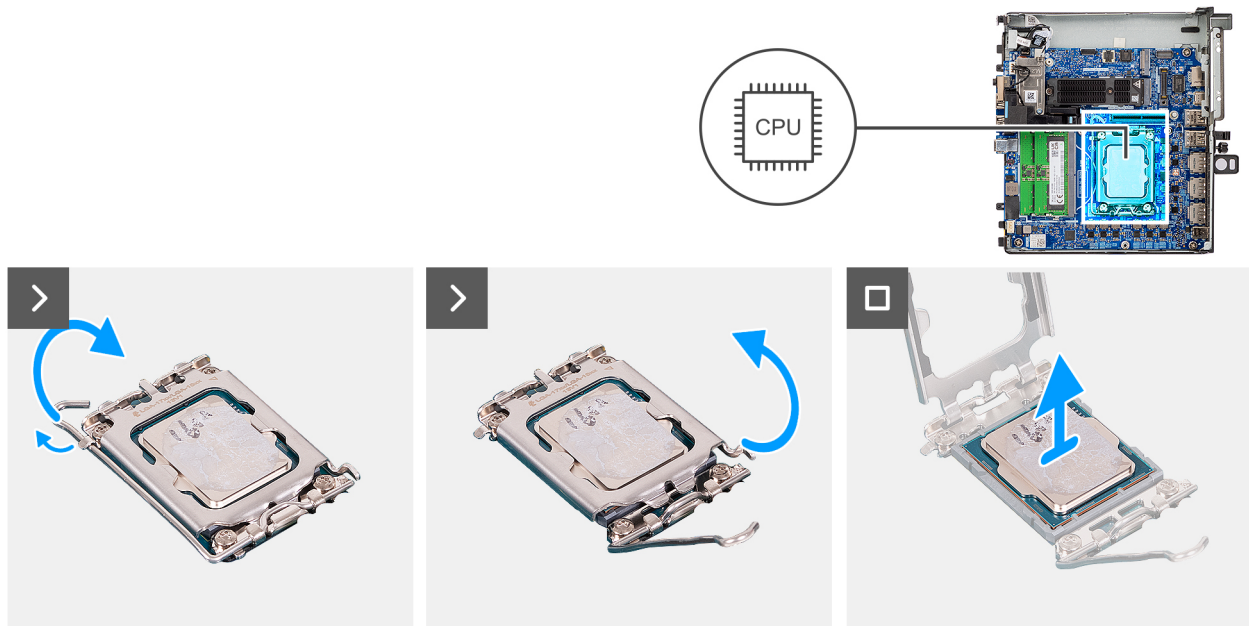

Figure 48. Removing the processor

### Steps

1. Press the release lever down and then push it away from the processor to release it from the securing tab.
2. Extend the release lever completely and open the processor cover.

**CAUTION:** When removing the processor, do not touch any of the pins inside the socket or allow any objects to fall on the pins in the socket.

3. Gently lift the processor from the processor socket.

## Installing the processor

### Prerequisites

If you are replacing a component, remove the existing component before performing the installation procedure.

### About this task

The following images indicate the location of the processor and provide a visual representation of the installation procedure.



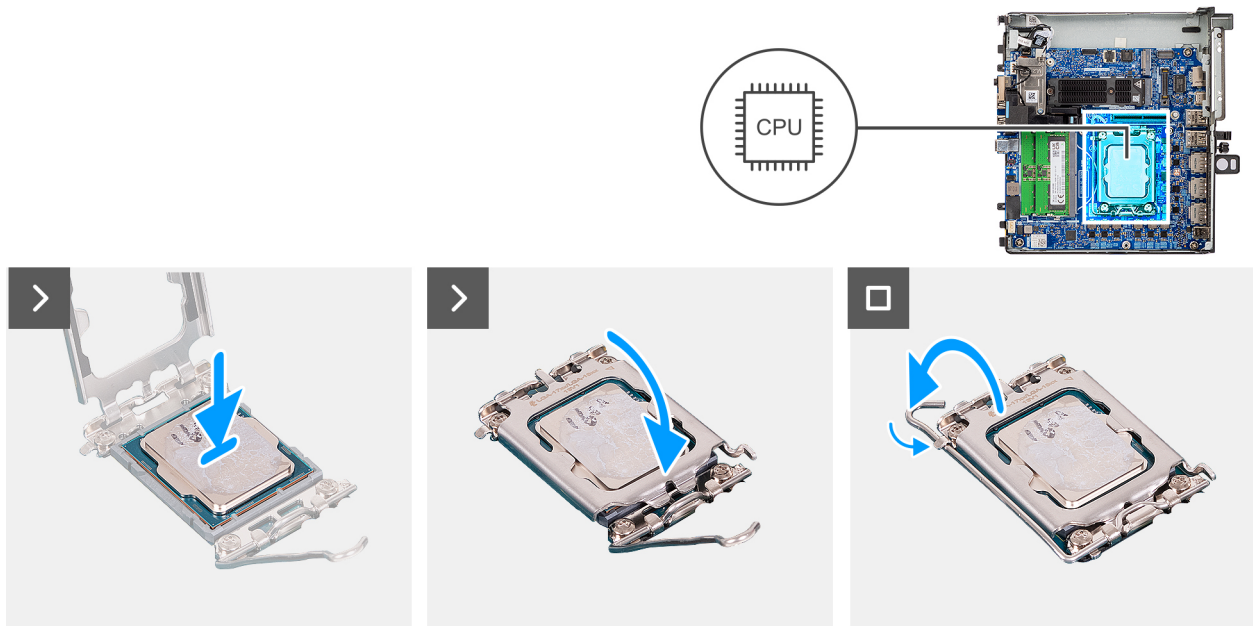

**Figure 49. Installing the processor**

### Steps

1. Ensure that the release lever on the processor socket is fully extended in the open position.

**NOTE:** The pin-1 corner of the processor has a triangle that aligns with the triangle on the pin-1 corner on the processor socket. When the processor is properly seated, all four corners are aligned at the same height. If one or more corners of the processor are higher than the others, the processor is not seated properly.

2. Align the notches on the processor with the tabs on the processor socket and place the processor in the processor socket.

**CAUTION:** Ensure that the processor-cover notch is positioned underneath the alignment post.

3. When the processor is fully seated in the socket, pivot the release-lever down and place it under the tab on the processor cover.

### Next steps

1. Install the [heat sink](#).
2. Install the [system fan](#).
3. Install the [riser-card module](#).
4. Install the [side cover](#).
5. Follow the procedure in [after working inside your computer](#).

## System board

### Removing the system board

#### Prerequisites

1. Follow the procedure in [before working inside your computer](#).
2. Remove the [side cover](#).
3. Remove the [memory modules](#).
4. Remove the [riser-card module](#).
5. Remove the [M.2 2230 SSD \(slot-one\)](#).
6. Remove the [M.2 2280 SSD \(slot-one\)](#).
7. Remove the [wireless card](#).

8. Remove the [coin-cell battery](#).
9. Remove the [speaker](#).
10. Remove the [system fan](#).
11. Remove the [heat sink](#).
12. Remove the [processor](#).
13. Remove the [optional module](#).

**About this task**

The following images indicate the connectors on your system board.

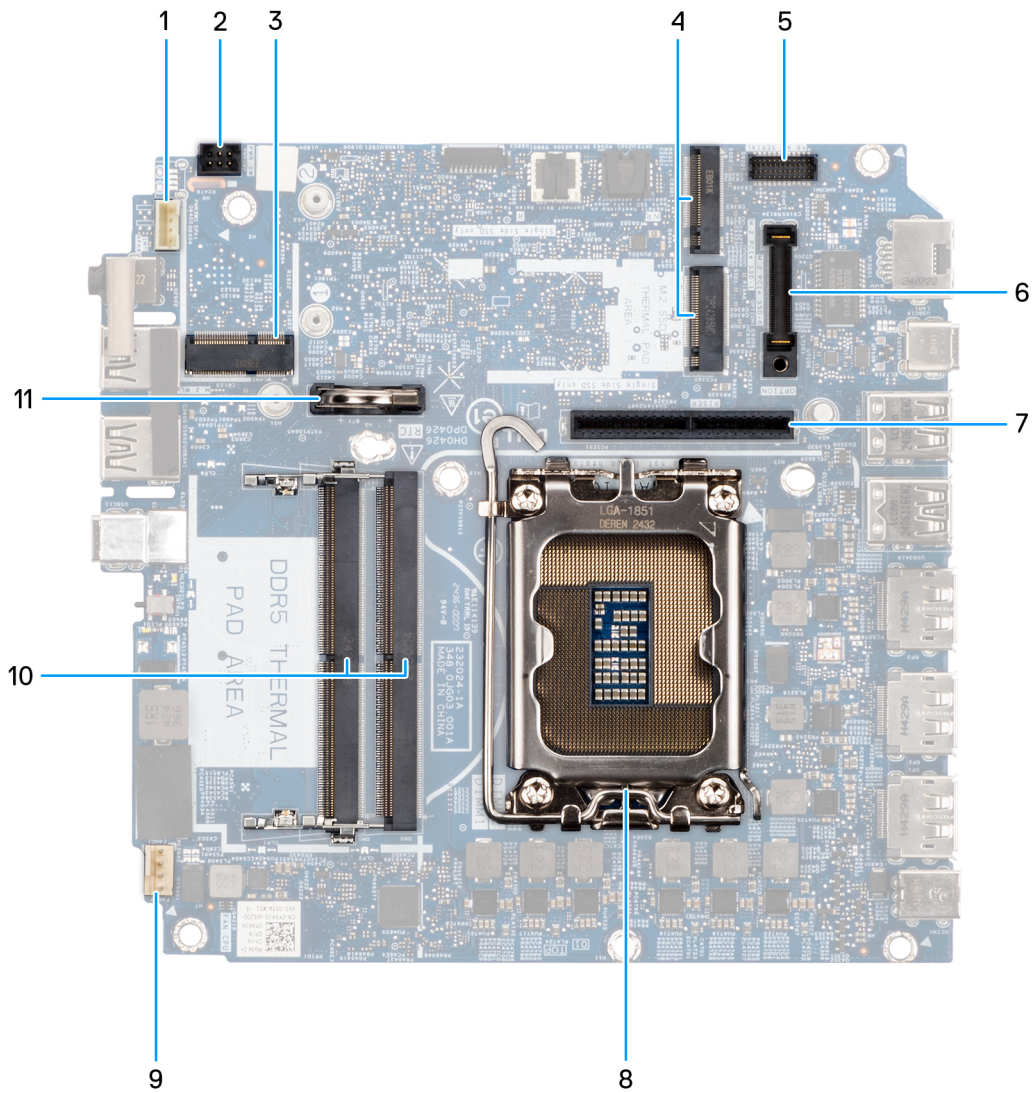

**Figure 50. System board connectors**

**Table 25. Dell Pro Max Micro FCM2250 system board connectors**

No	Connector	Description
1	INT SPKR	Internal speaker
2	PWR SW	Power button
3	M.2	Wireless card
4	M.2 PCIe SSD-0 and M.2 PCIe SSD-1	M.2 PCIe SSD slots

**Table 25. Dell Pro Max Micro FCM2250 system board connectors (continued)**

<b>No</b>	<b>Connector</b>	<b>Description</b>
5	KB MS SERIAL	Optional PS/2, serial port connector
6	OPTION	Optional module connector
7	PCIe RISER connector	The riser supports two PCIe Gen4 x8 open-end connector (Electrically x8 for slot1, x1 for slot2)
8	CPU	Processor socket
9	FANC1 and FANC2	CPU fan connector
10	DIMM1 and DIMM2	Memory module connectors
11	RTC	Coin-cell battery

The following images indicate the location of the system board and provide a visual representation of the removal procedure.





3x  
M3x5



1x  
M2x4.8

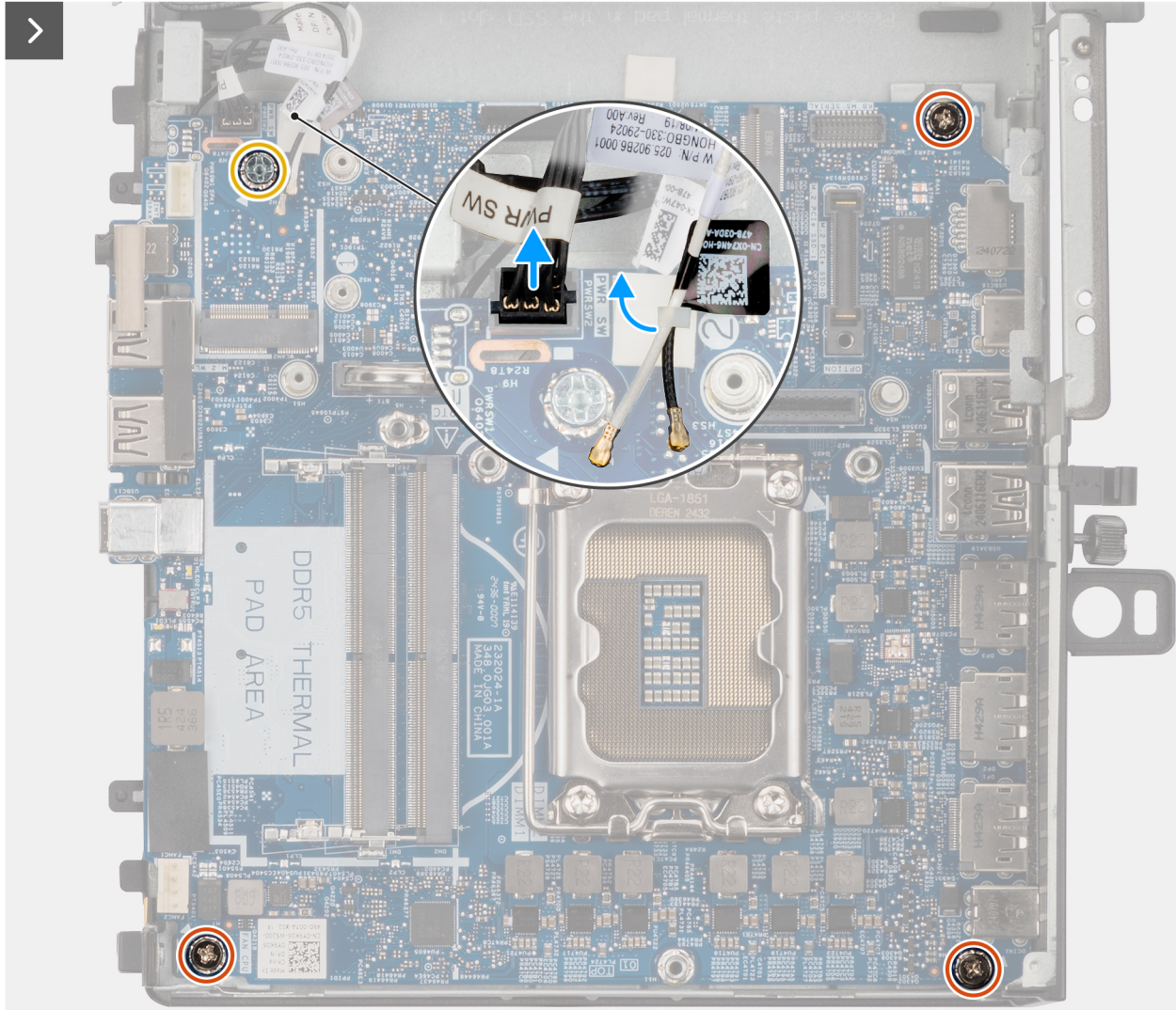
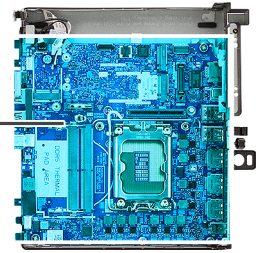
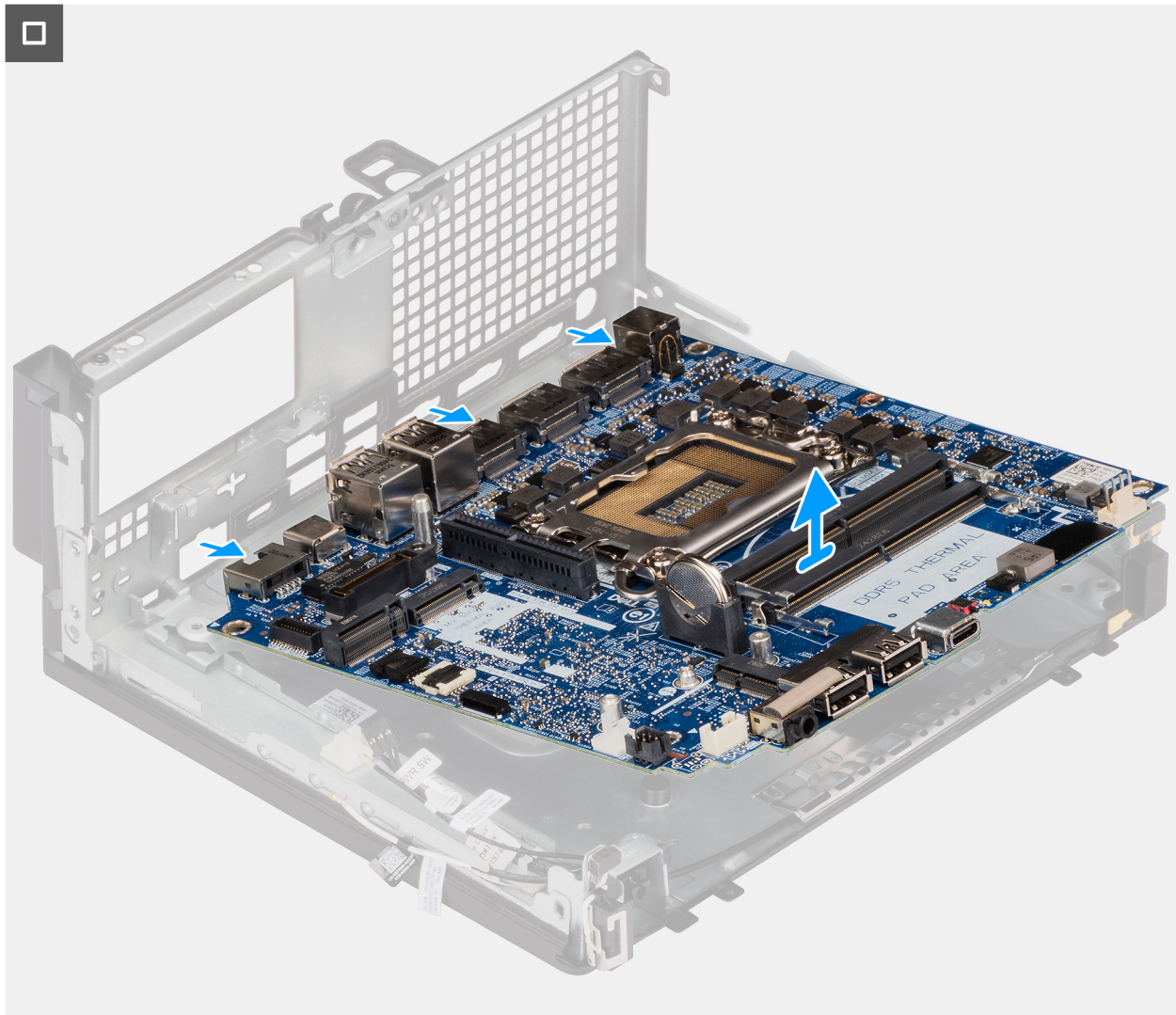

Figure 51. Removing the system board



**Figure 52. Removing the system board**

### Steps

1. Disconnect the power button cable from its connector on the system board.
2. Unroute the wireless antenna cables from the plastic routing guide.
3. Remove the screw (M2x4.8) and three screws (M3x5) that secure the system board to the chassis.
4. Slide and lift the system board away from the chassis.

## Installing the system board

### Prerequisites

If you are replacing a component, remove the existing component before performing the installation procedure.

### About this task

The following image indicates the connectors on your system board.



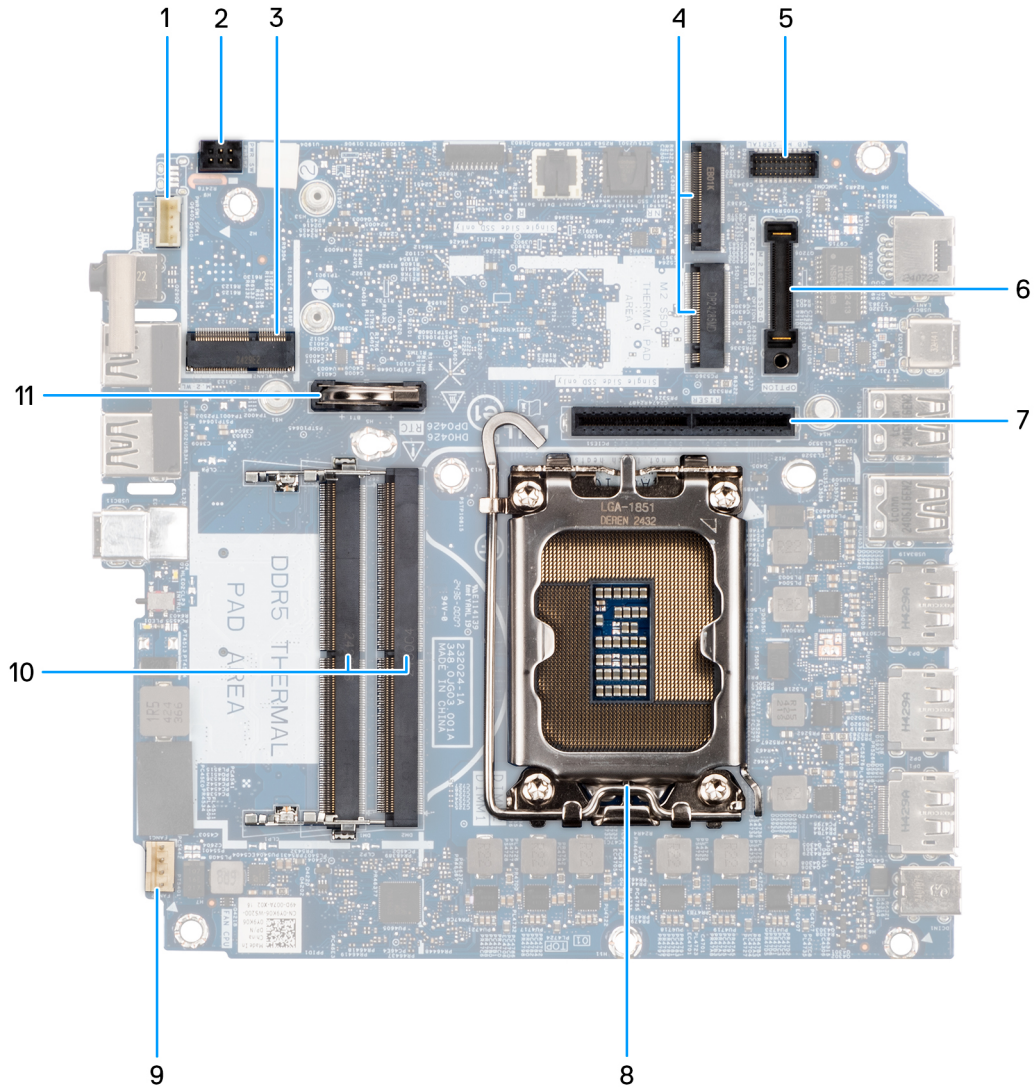

Figure 53. System board connectors

Table 26. Dell Pro Max Micro FCM2250 system board connectors

No	Connector	Description
1	INT SPKR	Internal speaker
2	PWR SW	Power button
3	M.2	Wireless card
4	M.2 PCIe SSD-0 and M.2 PCIe SSD-1	M.2 PCIe SSD slots
5	KB MS SERIAL	Optional PS/2, serial port connector
6	OPTION	Optional module connector
7	PCIe RISER connector	The riser supports two PCIe Gen4 x8 open-end connector (Electrically x8 for slot1, x1 for slot2)
8	CPU	Processor socket
9	FANC1 and FANC2	CPU fan connector
10	DIMM1 and DIMM2	Memory module connectors

**Table 26. Dell Pro Max Micro FCM2250 system board connectors (continued)**

No	Connector	Description
11	RTC	Coin-cell battery

The following images indicate the location of the system board and provide a visual representation of the installation procedure.



**3x**  
M3x5



**1x**  
M2x4.8

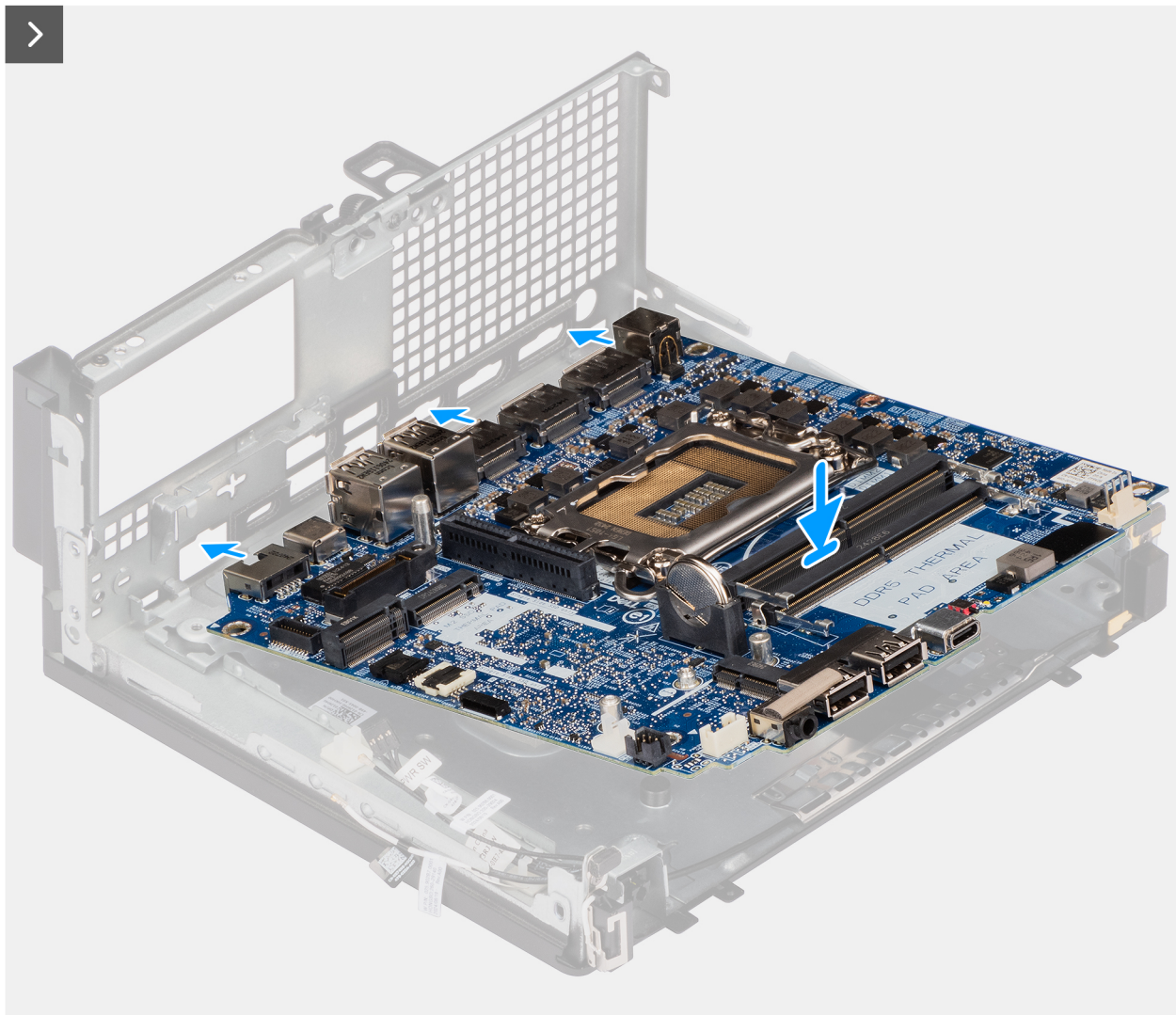
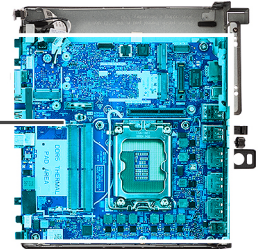

**Figure 54. Installing the system board**



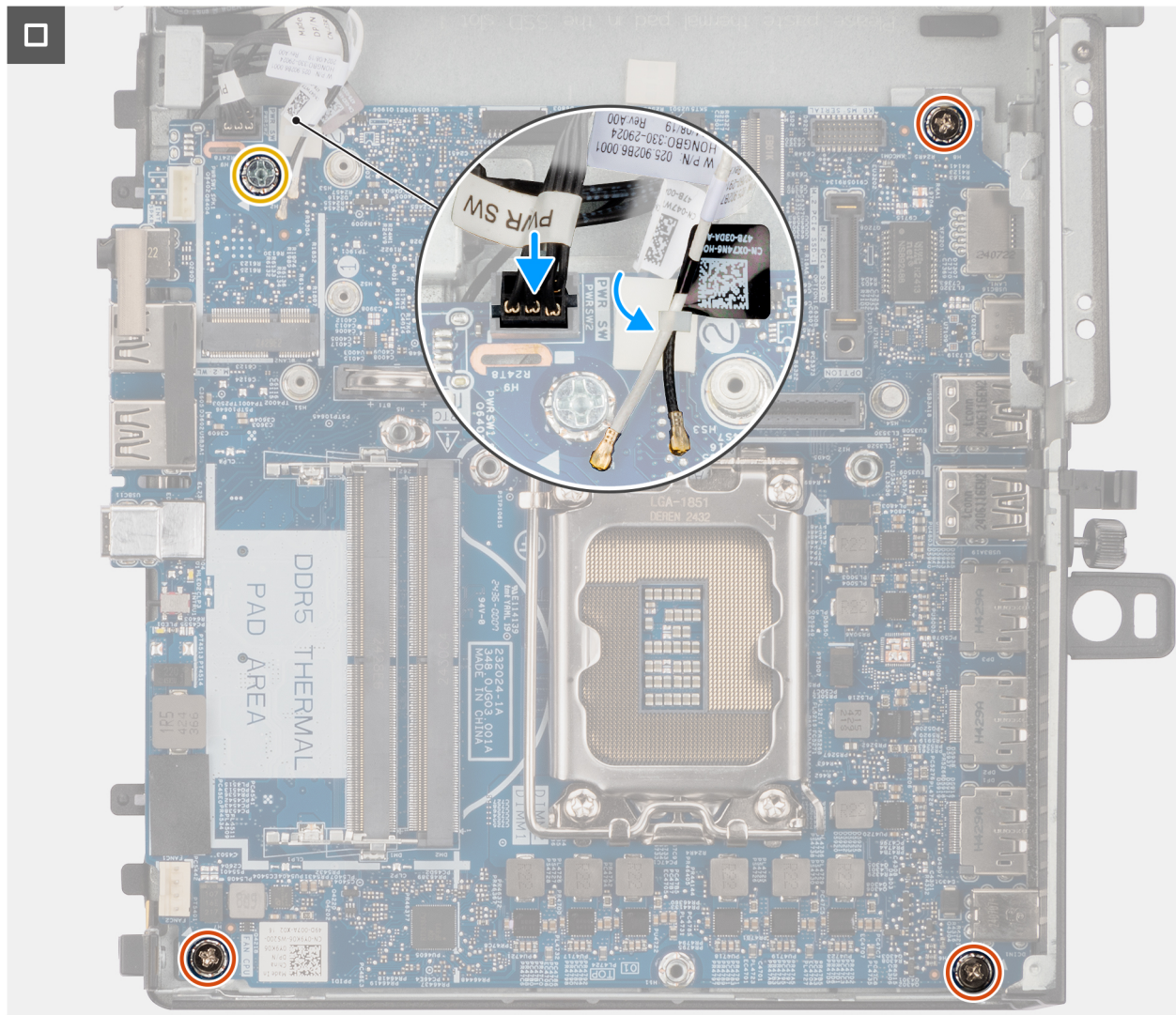

**Figure 55. Installing the system board**

**Steps**

1. At an angle, carefully slide to align the ports on the system board to the port slots on the chassis.
2. Align the screw holes on the system board with the screw holes on the chassis.
3. Replace the three screws (M3x5) and screw (M2x4.8) to secure the system board to the chassis.
4. Connect the power button cable to its connector on the system board.
5. Route the wireless antenna cables through the plastic routing guide.

**Next steps**

1. Install the [optional modules](#).
2. Install the [processor](#).
3. Install the [heat sink](#).
4. Install the [system fan](#).
5. Install the [speaker](#).
6. Install the [coin-cell battery](#).
7. Install the [wireless card](#).
8. Install the [M.2 2280 SSD \(slot-one\)](#).
9. Install the [M.2 2230 SSD \(slot-one\)](#).
10. Install the [riser-card module](#).
11. Install the [memory modules](#).
12. Install the [side cover](#).



13. Follow the procedure in [after working inside your computer](#).

## Power button

### Removing the power button

#### Prerequisites

1. Follow the procedure in [before working inside your computer](#).
2. Remove the [side cover](#).
3. Remove the [riser-card module](#).

#### About this task

The following images indicate the location of the power button and provide a visual representation of the removal procedure.

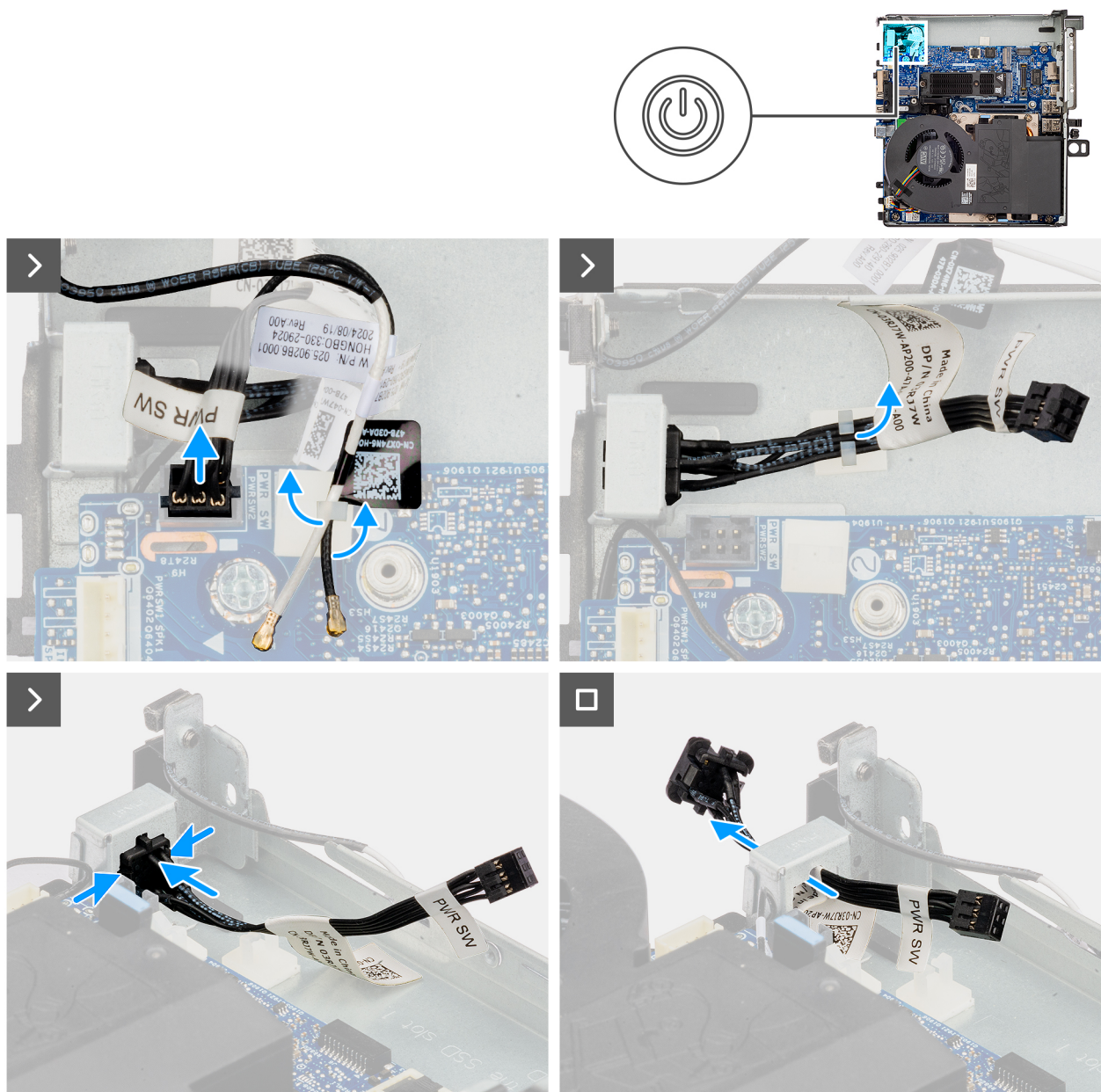

Figure 56. Removing the power button

**Steps**

1. Disconnect the power-button cable from the connector on the system board.
2. Unroute the wireless antenna cables from the plastic routing guide.
3. Unroute the power-button cable from the plastic routing guide.
4. Press the release tabs on the power-button head and slide the power-button cable out from the front-side chassis of the computer.
5. Pull the power-button cable out from the computer.

## Installing the power button

**Prerequisites**

If you are replacing a component, remove the existing component before performing the installation procedure.

**About this task**

The following images indicate the location of the power button and provide a visual representation of the installation procedure.

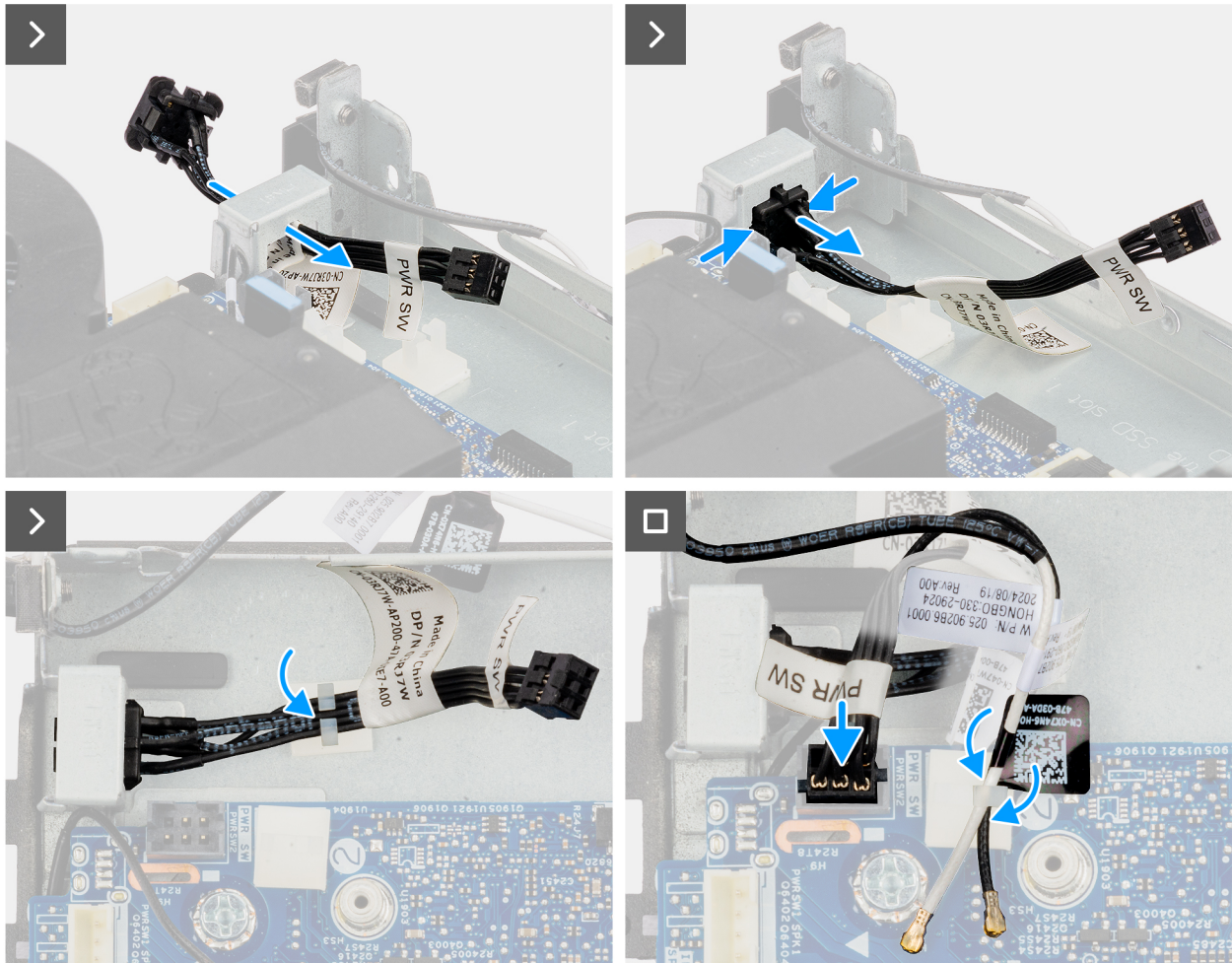
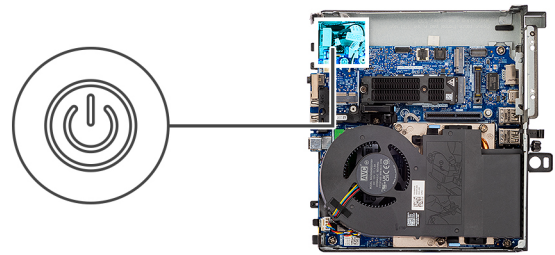

**Figure 57. Installing the power button**

**Steps**

1. Insert the power-button cable into the slot from the front-side of the computer.
2. Press the power-button head until it clicks into the place in the chassis.
3. Route the power-button cable through the plastic routing guide.
4. Route the wireless antenna cables through the plastic routing guide.
5. Align and connect the power-button cable to the connector on the system board.

**Next steps**

1. Install the [riser-card module](#).
2. Install the [side cover](#).
3. Follow the procedure in [after working inside your computer](#).



# Internal antenna

## Removing the internal antenna—location one

### Prerequisites

1. Follow the procedure in [before working inside your computer](#).
2. Remove the [side cover](#).
3. Remove the [riser-card module](#).
4. Remove the [wireless card](#).

### About this task

The following images indicate the location of the internal antenna and provide a visual representation of the removal procedure.

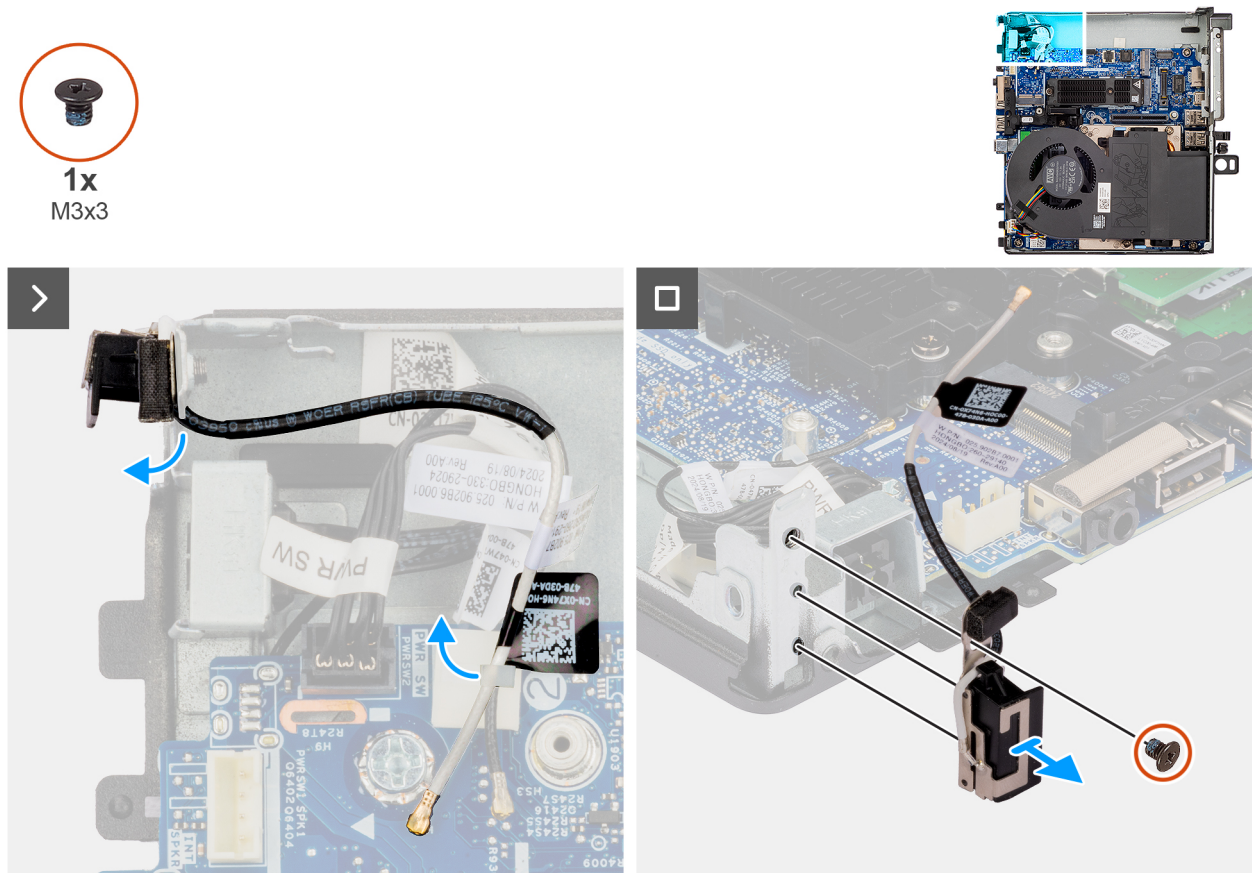

Figure 58. Removing the internal antenna—location one

### Steps

1. Unroute the antenna cable from the routing guides using a plastic scribe.
2. Remove the screw (M3x3) that secures the internal antenna module to the chassis.
3. Pull to remove the internal antenna module away from the chassis.

## Installing the internal antenna—location one

### Prerequisites

If you are replacing a component, remove the existing component before performing the installation procedure.



### About this task

The following images indicate the location of the Internal antenna and provide a visual representation of the installation procedure.

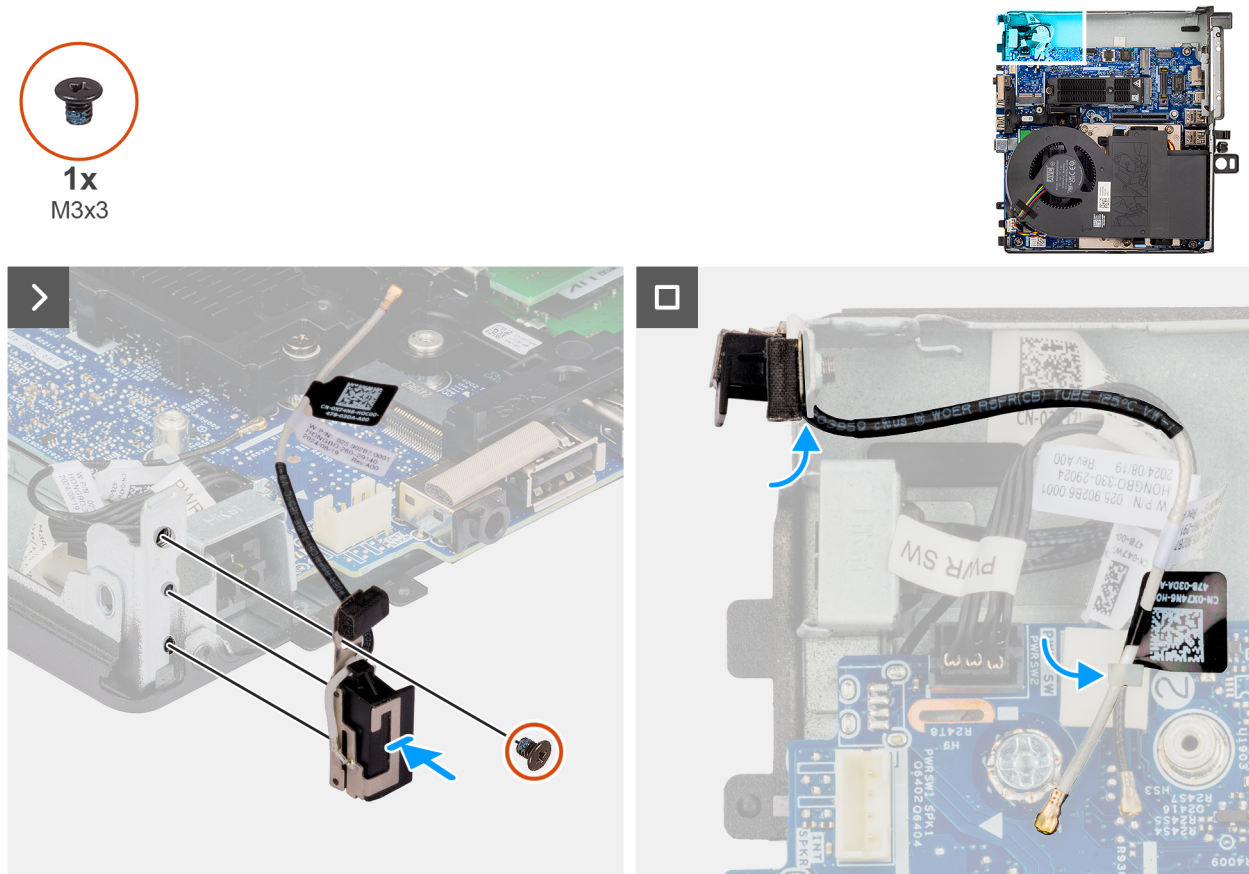

**Figure 59. Installing the internal antenna—location one**

### Steps

1. Align and insert the internal antenna module into its slot on the chassis.
2. Replace the screw (M3x3) to secure the internal antenna module to the chassis.
3. Route the antenna cable through the routing guides using a plastic scribe.

### Next steps

1. Install the [wireless card](#).
2. Install the [riser-card module](#).
3. Install the [side cover](#).
4. Follow the procedure in [after working inside your computer](#).

## Removing the internal antenna—location two

### Prerequisites

1. Follow the procedure in [before working inside your computer](#).
2. Remove the [side cover](#).
3. Remove the [riser-card module](#).
4. Remove the [wireless card](#).

### About this task

The following images indicate the location of the internal antenna and provide a visual representation of the removal procedure.



1x  
M3x3

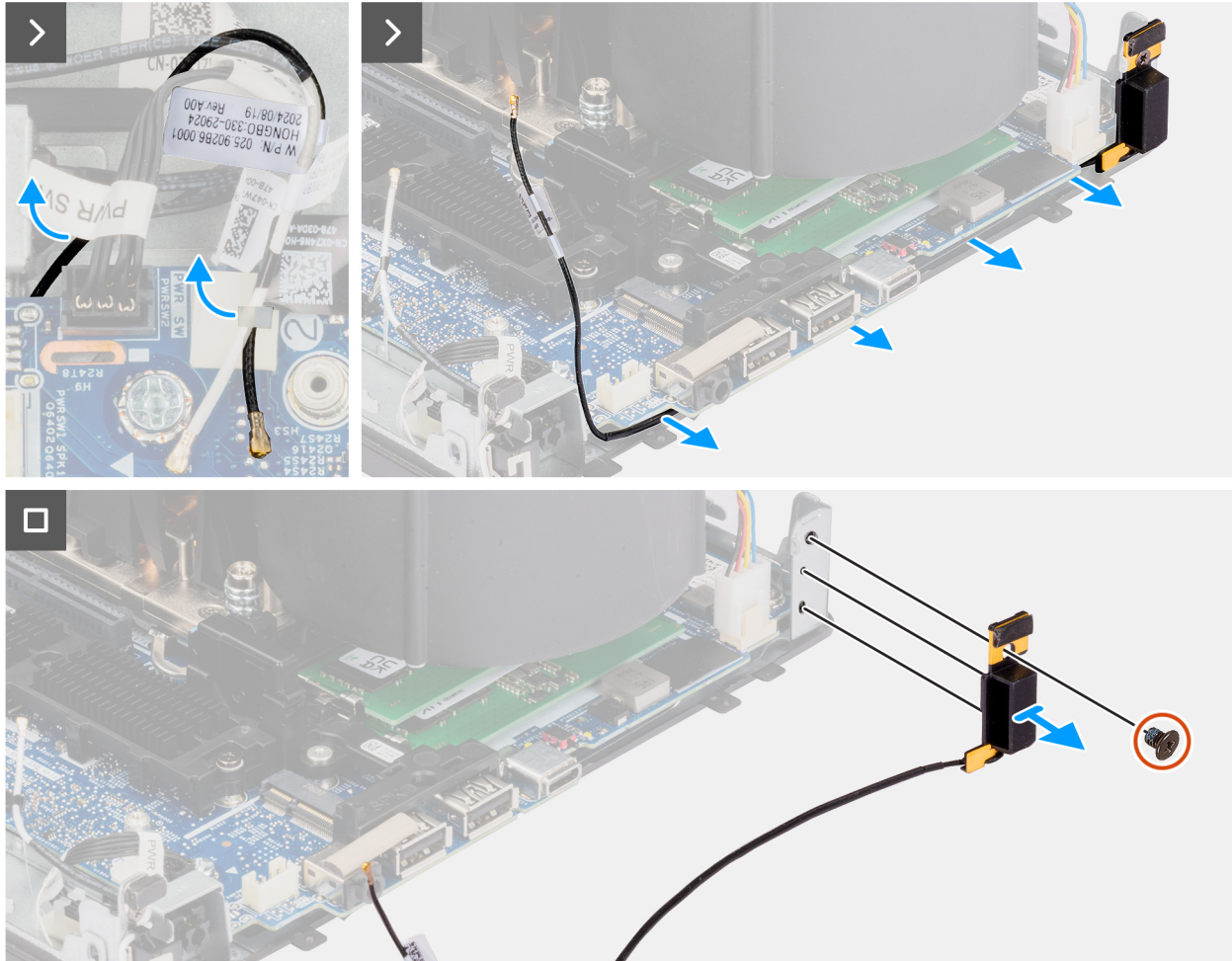

Figure 60. Removing the internal antenna—location two

### Steps

1. Unroute the antenna cables from the routing guides in the chassis using a plastic scribe.
2. Pry the metallic routing guide and unroute the antenna cables from the chassis.
3. Remove the screw (M3x3) that secures the internal antenna module to the chassis.
4. Pull to remove the internal antenna module away from the chassis.

## Installing the internal antenna—location two

### Prerequisites

If you are replacing a component, remove the existing component before performing the installation procedure.

### About this task

The following image indicates the location of the Internal antenna and provides a visual representation of the installation procedure.



1x  
M3x3

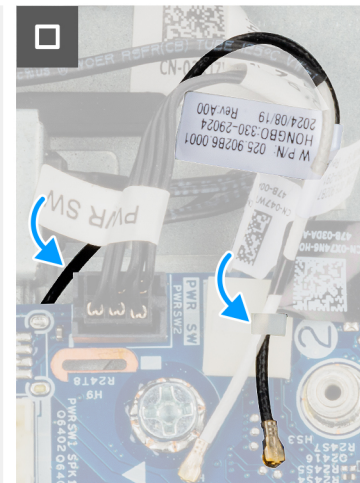
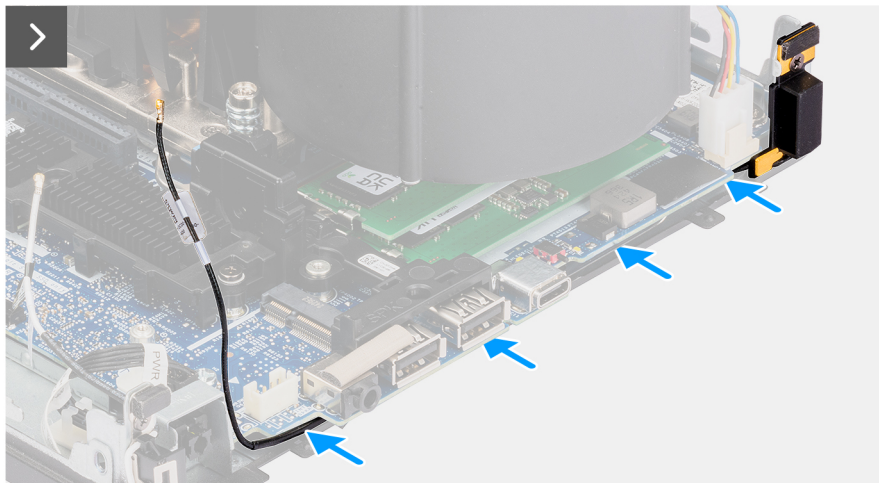
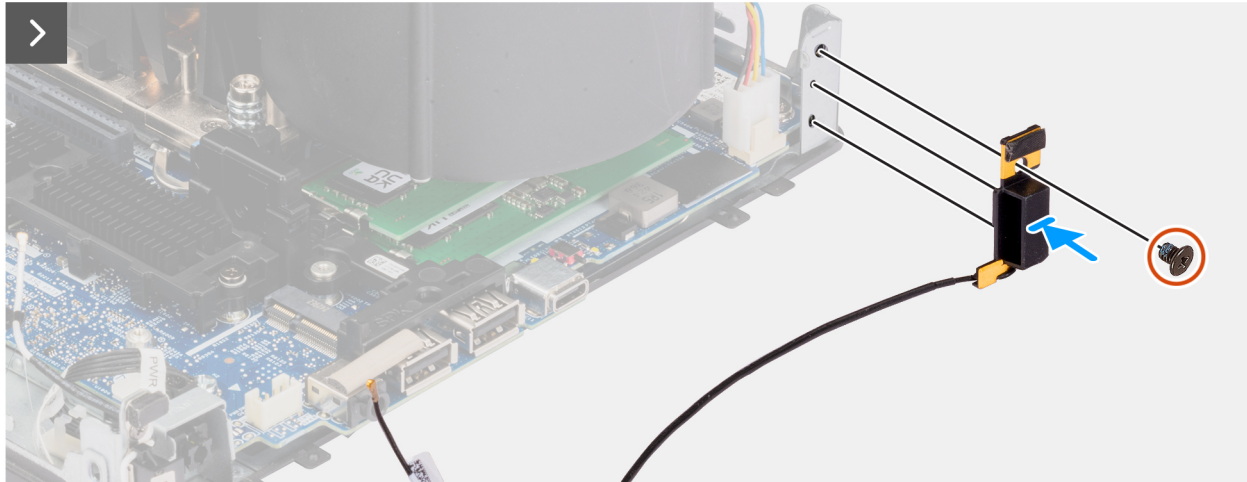

**Figure 61. Installing the internal antenna—location two**

### Steps

1. Align and insert the internal antenna module into its slot on the chassis.
2. Replace the screw (M3x3) to secure the internal antenna module to the chassis.
3. Route the antenna cable through the metallic routing guide on the chassis using a plastic scribe.
4. Route the antenna cable through the plastic routing guides on the chassis using a plastic scribe.

### Next steps

1. Install the [wireless card](#).
2. Install the [riser-card module](#).
3. Install the [side cover](#).
4. Follow the procedure in [after working inside your computer](#).

# Software

This chapter details the supported operating systems along with instructions on how to install the drivers.

## Operating system

Your Dell Pro Max Micro FCM2250 supports the following operating systems:

- Windows 11 Home, 64-bit
- Windows 11 Pro, 64-bit
- Windows 11 Pro National Education, 64-bit
- Windows 11 Pro for Workstations
- Ubuntu Linux 24.04 LTS, 64-bit

## Drivers and downloads

When troubleshooting, downloading, or installing drivers, it is recommended that you read the [Dell Knowledge Base article Drivers and Downloads FAQs](#).



# BIOS Setup

**CAUTION:** Certain changes can make your computer work incorrectly. Before you change the settings in BIOS Setup, it is recommended that you note down the original settings for future reference.

**NOTE:** Depending on the computer and the installed devices, the options that are listed in this section may differ.

Use BIOS Setup for the following purposes:

- Get information about the hardware installed in your computer, such as the amount of RAM and the capacity of the storage device.
- Change the system configuration information.
- Set or change user-selectable options such as the user password, enabling or disabling base devices, and configuring hard drive settings.

## Entering BIOS Setup program

### About this task

Turn on (or restart) your computer and press F2 immediately.

## Navigation keys

**NOTE:** For most of the BIOS Setup options, changes that you make are recorded but do not take effect until you restart the computer.

**Table 27. Navigation keys**

Keys	Navigation
Up arrow	Moves to the previous field.
Down arrow	Moves to the next field.
Enter	Selects a value in the selected field (if applicable) or follows the link in the field.
Spacebar	Expands or collapses a drop-down list, if applicable.
Tab	Moves to the next focus area.
Esc	Moves to the previous page until you view the main screen. Pressing Esc in the main screen displays a message that prompts you to save any unsaved changes and restart the computer.

## F12 One Time Boot menu

To enter the One Time Boot menu, turn on or restart your computer, and then press F12 immediately.

**NOTE:** If you are unable to enter the One Time Boot menu, repeat the above action.

The One Time Boot menu displays the devices that you can boot from and also display the options to start diagnostics. The boot menu options are:

- Removable Drive (if available)

- STXXXX Drive (if available)

**NOTE:** XXX denotes the SATA drive number.

- Optical Drive (if available)
- SATA Hard Drive (if available)
- Diagnostics

The One Time Boot menu screen also displays the option to access BIOS Setup.

## BIOS Setup options

**NOTE:** Depending on your computer and its installed devices, the items that are listed in this section may or may not be displayed.

**Table 28. BIOS Setup options—Overview menu**

Overview	Description
<b>Dell Pro Max Micro FCM2250</b>	
BIOS Version	Displays the BIOS version number.
Service Tag	Displays the Service Tag of the computer.
Asset Tag	Displays the Asset Tag of the computer.
Manufacture Date	Displays the manufacture date of the computer.
Ownership Date	Displays the ownership date of the computer.
Express Service Code	Displays the Express Service Code of the computer.
Ownership Tag	Displays the Ownership Tag of the computer.
<b>Processor Information</b>	
Processor Type	Displays the processor type.
Maximum Clock Speed	Displays the maximum processor clock speed.
Minimum Clock Speed	Displays the minimum processor clock speed.
Current Clock Speed	Displays the current processor clock speed.
Core Count	Displays the number of cores on the processor.
Processor ID	Displays the processor identification code.
Processor L2 Cache	Displays the processor L2 cache size.
Processor L3 Cache	Displays the processor L3 cache size.
Microcode Version	Displays the microcode version.
Intel vPro Technology	Allows computers to be fixed and maintained remotely.
<b>Memory Information</b>	
Memory Installed	Displays the total memory installed on the computer.
Memory Available	Displays the total computer memory available.
Memory Speed	Displays the memory speed.
Memory Technology	Displays the technology that is used for the memory.
DIMM1 Size	Displays the memory on DIMM1 slot.
DIMM2 Size	Displays the memory on DIMM2 slot.
<b>Devices Information</b>	

**Table 28. BIOS Setup options—Overview menu (continued)**

Overview	Description
Video Controller	Displays the type of video controller available on the computer.
Video Memory	Displays the video memory information of the computer.
Wi-Fi Device	Displays the wireless device information of the computer.
Video BIOS Version	Displays the video BIOS version of the computer.
Native Resolution	Displays the native resolution of the computer.
Audio Controller	Displays the audio controller information of the computer.
Bluetooth Device	Displays the Bluetooth device information of the computer.
LOM MAC Address	Displays the LAN On Motherboard (LOM) MAC address of the computer.
dGPU Video Controller	Displays the discrete video controller information of the computer.
Slot 1	Displays the video compatibility information of the computer.
Slot 2	Displays the video compatibility information of the computer.

**Table 29. BIOS Setup options—Boot Configuration menu**

Boot Configuration	Description
<b>Boot Sequence</b>	
Boot Sequence	Displays the boot sequence.
Enable PXE Boot Priority	Enables or disables PXE boot priority. By default, the <b>Enable PXE Boot Priority</b> option is disabled.
Extended IPV4 PXE Boot Timeout	Allows to set time for extended IPV4 PXE Boot timeout.
Force PXE On Next Boot	Enables or disables Force PXE on Next Boot. By default, the option is not enabled.
<b>Secure Boot</b>	
Enable Secure Boot	Enable or disable the secure boot feature. By default, the option is not enabled.
Secure Boot Mode	Enable or disable to change the secure boot mode options. By default, the <b>Deployed Mode</b> is enabled.
<b>Expert Key Management</b>	
Enable Custom Mode	Enable or disable custom mode. By default, the custom mode option is not enabled.
Custom Mode Key Management	Select the custom values for expert key management. By default, the <b>PK</b> is enabled.

**Table 30. BIOS Setup options—Integrated Devices menu**

Integrated Devices	Description
<b>Date/Time</b>	
Date	Sets the computer date in MM/DD/YYYY format. Changes to the date format take effect immediately.

**Table 30. BIOS Setup options—Integrated Devices menu (continued)**

<b>Integrated Devices</b>	<b>Description</b>
Time	Sets the computer time in HH/MM/SS 24-hour format. You can switch between a 12-hour and 24-hour clock. Changes to the time format take effect immediately.
<b>Audio</b>	
Enable Audio	Enables all integrated audio controller. By default, all the options are enabled.
Enable Microphone	Enables the microphone. By default, the <b>Enable Microphone</b> option is enabled.  <b>NOTE:</b> Depending on the configuration ordered, the microphone setup option may not be available.
Enable Internal Speaker	Enables the internal speaker. By default, the <b>Enable Internal Speaker</b> option is enabled.
<b>USB Configuration</b>	Enable or disable booting from USB mass storage devices through the boot sequence or boot menu. By default, all the options are enabled.
<b>Enable Front USB Ports</b>	Enable or disable the individual front USB ports. By default, <b>Enable Front USB Ports</b> is enabled.
<b>Enable Rear USB Ports</b>	Enable or disable the individual rear USB ports. By default, <b>Enable Rear USB Ports</b> is enabled.
<b>Enable USB Boot Support</b>	Enable or disable the USB boot support. By default, <b>Enable USB Boot Support</b> is enabled.

**Table 31. BIOS Setup options—Storage menu**

<b>Storage</b>	<b>Description</b>
SATA/NVMe Operation	Enable or disable the operating mode of the integrated SATA/NVMe storage device controller. By default, the <b>RAID On</b> option is enabled.
Storage Interface	Displays the information of various onboard drives.
Port Enablement	Enables or disables the M.2 PCIe SSD-0 and M.2 PCIe SSD-1 options. By default, both <b>M.2 PCIe SSD-0</b> and <b>M.2 PCIe SSD-1</b> options are enabled.
<b>SMART Reporting</b>	
Enable SMART Reporting	Enable or disable Self-Monitoring, Analysis, and Reporting Technology (SMART) during computer startup. By default, the <b>Enable SMART Reporting</b> option is not enabled.
<b>Drive Information</b>	Displays the information of onboard drives.
M.2 PCIe SSD-0 Type Device	Displays the M.2 PCIe SSD-0 type information of the computer. Displays the M.2 PCIe SSD-0 device information of the computer.
M.2 PCIe SSD-1	Displays the M.2 PCIe SSD-1 type information of the computer.



**Table 31. BIOS Setup options—Storage menu (continued)**

Storage	Description
Type Device	Displays the M.2 PCIe SSD-1 device information of the computer.

**Table 32. BIOS Setup options—Display menu**

Display	Description
<b>Multi-Display</b>	
<b>Primary Display</b>	Determines the primary display when multiple controllers are available on the computer By default, the <b>Auto</b> option is enabled.
<b>Full Screen Logo</b>	Enable or disable full screen logo. By default, the option is not enabled.

**Table 33. BIOS Setup options—Connection menu**

Connection	Description
<b>Network Controller Configuration</b>	
Integrated NIC	Controls the on-board LAN controller. By default, the <b>Enabled with PXE</b> option is enabled.
<b>Wireless Device Enable</b>	
WLAN	Enables or disables the internal WLAN device. By default, the <b>WLAN</b> option enabled.
Bluetooth	Enables or disables the internal Bluetooth device. By default, the <b>Bluetooth</b> option enabled.
<b>Enable UEFI Network Stack</b>	Enable or disable UEFI Network Stack and controls the on-board LAN Controller. By default, the <b>Auto Enabled</b> option is enabled.
<b>HTTP(s) Boot Feature</b>	
HTTP(s) Boot	Enable or disable the HTTP(s) Boot feature. By default, the <b>HTTP(s) Boot</b> option is enabled.
HTTP(s) Boot Modes	With Auto Mode, the HTTPs Boot extracts Boot URL from the DHCP. With Manual Mode, the HTTPs Boot reads Boot URL from the user-provided data. By default, the <b>Auto Mode</b> option is enabled.

**Table 34. BIOS Setup options—Power menu**

Power	Description
<b>USB PowerShare</b>	
Enable USB PowerShare	Enable or disable the USB PowerShare. By default, the <b>Enable USB PowerShare</b> option is disabled
Thermal Management	Enables cooling fan and processor heat management to adjust the computer performance, noise, and temperature. By default, the <b>Optimized</b> option is enabled.

**Table 34. BIOS Setup options—Power menu (continued)**

<b>Power</b>	<b>Description</b>
<b>USB Wake Support</b>	
Enable USB Wake Support	When enabled, you can use the USB devices like a mouse or keyboard to wake your computer from standby. By default, the option is enabled.
<b>AC Behavior</b>	
AC Recovery	Enables the system to determine what happens when AC power is restored after unexpected loss of AC power. By default, the <b>Power Off</b> option is enabled.
Block Sleep	Enables to block entering sleep (S3) mode in the operating system. By default, the <b>Block Sleep</b> option is disabled.
<b>Deep Sleep Control</b>	Enable or disable the Deep Sleep mode support. By default, this option is <b>Disabled</b> .
<b>Fan Control Override</b>	Enable or disable the Fan Control Override. This allows a software or hardware to override the settings for controlling a computer's fan speed. By default, the <b>Fan Control Override</b> option is disabled.

**Table 35. BIOS Setup options—Security menu**

<b>Security</b>	<b>Description</b>
TPM 2.0 Security	The Trusted Platform Module (TPM) provides various cryptographic services which serve as the cornerstone for many platform security technologies. Trusted Platform Module (TPM) is a security device that stores computer-generated keys for encryption and features such as BitLocker, Virtual Secure Mode, remote Attestation. By default, the <b>TPM 2.0 Security On</b> option is enabled. For additional security, Dell Technologies recommends keeping <b>Trusted Platform Module (TPM)</b> enabled to allow these security technologies to fully function.
Attestation Enable	Enables to control whether the Trusted Platform Module (TPM) Endorsement Hierarchy is available to the operating system. By default, the <b>Attestation Enable</b> option is enabled.
Key Storage Enable	Enables to control whether the Trusted Platform Module (TPM) Storage Hierarchy is available to the operating system. By default, the <b>Key Storage Enable</b> option is enabled.
Clear	Enables to clear the TPM owner information and returns the TPM to the default state. By default, the <b>Clear</b> option is disabled.
PPI ByPass for Clear Commands	Controls the TPM Physical Presence Interface (PPI). By default, the <b>PPI ByPass for Clear Commands</b> option is disabled.
<b>Intel Total Memory Encryption</b>	
Multi-Key Total Memory Encryption (Up to 16days)	Protects the memory from physical attacks including freeze spray.

**Table 35. BIOS Setup options—Security menu (continued)**

Security	Description
	By default, the <b>Multi-Key Total Memory Encryption (Up to 16days)</b> option is disabled.
<b>Chassis intrusion</b>	Controls the chassis intrusion feature. By default, the option is <b>Disabled</b> .
Data Wipe on Next Boot	
Start Data Wipe	Enable or disable the data wipe on next boot. By default, the option is disabled.
Absolute	Absolute Software provides various cyber security solutions, some requiring software preloaded on Dell computers and integrated into the BIOS. To use these features, you must enable the Absolute BIOS setting and contact Absolute for configuration and activation.  By default, the <b>Enable Absolute</b> option is enabled.  For additional security, Dell Technologies recommends keeping the <b>Absolute</b> option enabled.   <b>NOTE:</b> When the Absolute features are activated, the Absolute integration cannot be disabled from the BIOS setup screen.
UEFI Boot Path Security	Controls whether or not the computer will prompt the user to enter the admin password (if set) when booting to a UEFI boot device from the F12 boot menu. By default, the <b>Always Except Internal HDD</b> option is enabled.
<b>Authenticated BIOS Interface</b>	
<b>Enable Authenticated BIOS Interface</b>	Enable or disable the Authenticated BIOS Interface option. By default, the option is disabled.
Legacy Manageability Interface Access	Allows the platform administrator to control access through the Legacy Manageability Interface when Authenticated BIOS Interface (ABI) is enabled and provisioned. By default, the option is <b>Enabled</b> .
Firmware Device Tamper Detection	Allows you to control the firmware device tamper detection feature. This feature notifies the user when the firmware device is tampered. When enabled, a screen warning messages are displayed on the computer and a tamper detection event is logged in the BIOS Events log. The computer fails to reboot until the event is cleared.  By default, the <b>Silent</b> option is enabled.
Clear Firmware Device Tamper Detection	

**Table 36. BIOS Setup options—Passwords menu**

Passwords	
Admin Password	The Administrator Password prevents unauthorized access to the BIOS Setup options. Once the administrator password is set, the BIOS setup options can only be modified after providing the correct password.  The following rules and dependencies apply to the Administrator Password - <ul style="list-style-type: none"> <li>• The administrator password cannot be set if computer and/or internal storage passwords are previously set.</li> <li>• The administrator password can be used in place of the computer and/or internal storage passwords.</li> </ul>

**Table 36. BIOS Setup options—Passwords menu (continued)**

<b>Passwords</b>	
	<ul style="list-style-type: none"> <li>When set, the administrator password must be provided during a firmware update.</li> <li>Clearing the administrator password also clears the computer password (if set).</li> </ul> <p>Dell Technologies recommends using an administrator password to prevent unauthorized changes to BIOS setup options.</p>
System Password	<p>The System Password prevents the computer from booting to an operating system without entering the correct password.</p> <p>The following rules and dependencies apply when the System Password is used -</p> <ul style="list-style-type: none"> <li>The computer shuts down when idle for approximately 10 minutes at the computer password prompt.</li> <li>The computer shuts down after three incorrect attempts to enter the computer password.</li> <li>The computer shuts down when the <b>Esc</b> key is pressed at the System Password prompt.</li> <li>The computer password is not prompted when the computer resumes from standby mode.</li> </ul> <p>Dell Technologies recommends using the computer password in situations where it is likely that a computer may be lost or stolen.</p>
M.2 PCIe SSD-0/SSD-1	Set, change, or delete the M.2 PCIe SSD-0 and/or SSD-1 password.
<b>Password Configuration</b>	
Upper Case Letter	Reinforces password must have at least one upper case letter. By default, the option is disabled.
Lower Case Letter	Reinforces password must have at least one lower case letter. By default, the option is disabled.
Digit	Reinforces password must have at least one digit. By default, the option is disabled.
Special Character	Reinforces password must have at least one special character. By default, the option is disabled.
Minimum Characters	Set the minimum characters allowed for password.
<b>Password Bypass</b>	When enabled, this always prompts for computer and internal hard drive passwords when powered on from the off state. By default, the <b>Disabled</b> option is enabled.
<b>Password Changes</b>	
Allow Non-Admin Password Changes	Enable or disable to change computer and hard drive password without the need for admin password. By default, the option is enabled.
<b>Admin Setup Lockout</b>	
Enable Admin Setup Lockout	Enables administrators control over how their users can or cannot access BIOS setup. By default, the option is disabled.
<b>Master Password Lockout</b>	



**Table 36. BIOS Setup options—Passwords menu (continued)**

<b>Passwords</b>	
Enable Master Password Lockout	When enabled, this will disable the master password support. By default, the option is disabled.
<b>Allow Non-Admin PSID Revert</b>	
Enable Allow Non-Admin PSID Revert	Controls access to the Physical Security ID (PSID) revert of NVMe hard-drives from the Dell Security Manager prompt. By default, the option <b>Disabled</b> is enabled.

**Table 37. BIOS Setup options—Update, Recovery menu**

<b>Update, Recovery</b>	
<b>BIOS Recovery from Hard Drive</b>	Enables the user to recover from certain corrupted BIOS conditions from a recovery file on the user primary hard drive or an external USB key. By default, the option is enabled.
<b>BIOS Downgrade</b>	
<b>Allow BIOS Downgrade</b>	Enable or disable the flashing of the computer firmware to previous revision is blocked. By default, the option is enabled.
<b>SupportAssist OS Recovery</b>	Enable or disable the boot flow for SupportAssist OS Recovery tool in the event of certain computer errors. By default, the option is enabled.
<b>BIOSConnect</b>	Enables or disables cloud Service operating system recovery if the main operating system fails to boot with the number of failures equal to or greater than the value specified by the Auto OS Recovery Threshold setup option and local Service operating system does not boot or is not installed. By default, the <b>BIOSConnect</b> option is enabled.
<b>Dell Auto OS Recovery Threshold</b>	Controls the automatic boot flow for SupportAssist System Resolution Console and for Dell OS Recovery Tool. By default, the threshold value is set to <b>2</b> .

**Table 38. System setup options—System Management menu**

<b>System Management</b>	
<b>Service Tag</b>	Display the Service Tag of the computer.
<b>Asset Tag</b>	Create a computer Asset Tag.
<b>Wake on LAN/WLAN</b>	Enable or disable the computer to power on by special LAN signals when it receives a wakeup signal from the WLAN. By default, the <b>Disabled</b> option is enabled.
<b>Auto on Time</b>	Enable to set the computer to turn on automatically every day or on a preselected date and time. This option can be configured only if the Auto On Time is set to Everyday, Weekdays, or Selected Days. By default, the option is disabled.
<b>Intel AMT Capability</b>	
Enable Intel AMT Capability	Enable or disable the Intel AMT capability. By default, the Restrict Preboot Access option is enabled.

**Table 38. System setup options—System Management menu (continued)**

<b>System Management</b>	
<b>SERR Messages</b>	Enable or disable SERR messages. By default, the option is enabled.
<b>First Power On Date</b>	
Set Ownership Date	Allows to set the Ownership date. By default, the option is disabled.
<b>Diagnostics</b>	
OS Agent Requests	Enable or disable the Dell OS Agent(s) capability of scheduling onboard diagnostics on a subsequent boot which helps assist in the prevention and resolution of hardware related issues.  By default, this option is enabled.
<b>Power-on-Self-Test Automatic Recovery</b>	Enable or disable the Power-on-Self-Test automatic recovery option. By default, the option is enabled.

**Table 39. BIOS Setup options—Keyboard menu**

<b>Keyboard</b>	
<b>Numlock LED</b>	
<b>Enable Numlock LED</b>	Enable or disable Numlock LED. By default, the option is enabled.
<b>Device Configuration Hotkey Access</b>	
Device Configuration Hotkey Access	Enable or disable users to access device configuration by using hotkeys. By default, the option is <b>Enabled</b> .

**Table 40. BIOS Setup options—Pre-boot Behavior menu**

<b>Preboot Behavior</b>	
<b>Adapter Warnings</b>	
Enable Adapter Warnings	Enable or disable the adapter warning messages. By default, the option is enabled.
<b>Warnings and Errors</b>	Enables or disables the action to be taken when a warning or error is encountered. By default, the <b>Prompt on Warnings and Errors</b> option is selected.  <b>NOTE:</b> Errors deemed critical to the operation of the computer hardware stop the functioning of the computer.
<b>Extend BIOS POST Time</b>	Set the BIOS POST time. By default, the <b>0 seconds</b> option is enabled.

**Table 41. BIOS Setup options—Performance menu**

<b>Performance</b>	
<b>Intel SpeedStep</b>	
Enable Intel SpeedStep Technology	Enables the computer to dynamically adjust processor voltage and core frequency, decreasing average power consumption and heat production.

**Table 41. BIOS Setup options—Performance menu (continued)**

<b>Performance</b>	
	By default, the option is enabled.
<b>PCIe Resizable Base Address Register (BAR)</b>	Enable or disable the PCIe resizable base address register support. By default, the option is disabled.

**Table 42. BIOS Setup options—System Logs menu**

<b>System Logs</b>	
<b>BIOS Event Log</b>	
Clear BIOS Event Log	Allows you to select option to keep or clear BIOS events logs. By default, the <b>Keep Log</b> option is selected.
<b>Power Event Log</b>	
Clear Power Event Log	Allows you to select option to keep or clear power events logs. By default, the <b>Keep Log</b> option is selected.

## Updating the BIOS

### Updating the BIOS in Windows

#### About this task

**CAUTION:** If BitLocker is not suspended before updating the BIOS, the BitLocker key is not recognized the next time you reboot the computer. You will then be prompted to enter the recovery key to proceed, and the computer displays a prompt for the recovery key on each reboot. Failure to provide the recovery key can result in data loss or an operating system reinstall. For more information, refer [Updating the BIOS on Dell systems with BitLocker enabled](#).

**CAUTION:** Do not turn off the computer during the BIOS flash update process. The computer may not boot if you turn off your computer.

#### Steps

- Go to [Dell Support Site](#).
- Go to **Identify your product or ask support**. In the box, enter the product identifier, model, service request or describe what you are looking for, and then click **Search**.
 

**NOTE:** If you do not have the Service Tag, click **Detect This PC**. The site automatically detects your device, and you can then click **Explore Product Support** to go to the support page for your device. You can also use the product ID or manually browse for your computer model.
- Click **Drivers & Downloads**.
- Select the operating system installed on your computer.
- In the **Category** drop-down list, select **BIOS**.
- Select the latest version of BIOS, and click **Download** to download the BIOS file for your computer.
- After the download is complete, navigate to the folder where the BIOS update file has been saved.
- Double-click the BIOS update file and follow the on-screen instructions.  
For more information, search [Dell Support Site](#).

# Updating the BIOS in Linux and Ubuntu

To update the system BIOS on a computer that is installed with Linux or Ubuntu, see [How to Update the Dell BIOS in the Ubuntu or Linux Environment](#) at [Dell Support Site](#).

# Updating the BIOS using the USB drive in Windows

### About this task

 **CAUTION:** If BitLocker is not suspended before updating the BIOS, the BitLocker key is not recognized the next time you reboot the computer. You will then be prompted to enter the recovery key to proceed, and the computer displays a prompt for the recovery key on each reboot. Failure to provide the recovery key can result in data loss or an operating system reinstall. For more information, refer [Updating the BIOS on Dell systems with BitLocker enabled](#).

 **CAUTION:** Do not turn off the computer during the BIOS flash update process. The computer may not boot if you turn off your computer.

### Steps

1. Go to [Dell Support Site](#).
2. Go to **Identify your product or ask support**. In the box, enter the product identifier, model, service request or describe what you are looking for, and then click **Search**.  
 **NOTE:** If you do not have the Service Tag, click **Detect This PC**. The site automatically detects your device, and you can then click **Explore Product Support** to go to the support page for your device. You can also use the product ID or manually browse for your computer model.
3. Click **Drivers & Downloads**.
4. Select the operating system installed on your computer.
5. In the **Category** drop-down list, select **BIOS**.
6. Select the latest version of BIOS, and click **Download** to download the BIOS file for your computer.
7. Create a bootable USB drive. For more information, search [Dell Support Site](#).
8. Copy the BIOS setup program file to the bootable USB drive.
9. Connect the bootable USB drive to the computer that needs the BIOS update.
10. Restart the computer and press **F12**.
11. Select the USB drive from the **One Time Boot Menu**.
12. Type the BIOS setup program filename and press **Enter**.  
The **BIOS Update Utility** appears.
13. Follow the on-screen instructions to complete the BIOS update.

# Updating the BIOS from the One-Time boot menu

To update the BIOS from the One-Time boot menu, see [Updating the BIOS from the One Time Boot Menu](#) at [Dell Support Site](#).

# System and setup password

 **CAUTION:** The password features provide a basic level of security for the data on your computer.

 **CAUTION:** Ensure that your computer is locked when it is not in use. Anyone can access the data that is stored on your computer, when left unattended.



**Table 43. System and setup password**

Password type	Description
System password	Password that you must enter to boot to your operating system.
Setup password	Password that you must enter to access and change the BIOS settings of your computer.

You can create a system password and a setup password to secure your computer.

 **NOTE:** The System and setup password feature is disabled by default.

## Assigning a System Setup password

### Prerequisites

You can assign a new System or Admin Password only when the status is set to **Not Set**. To enter BIOS System Setup, press F2 immediately after a power-on or reboot.

### Steps

1. In the **System BIOS** or **System Setup** screen, select **Passwords** and press Enter.  
The **Passwords** screen is displayed.
2. Select **System/Admin Password** and create a password in the **Enter the new password** field.  
Use the following guidelines to create the system password:
  - Password can be up to 32 characters.
  - The password can contain numbers from 0 to 9.
  - The password can contain alphabets A to Z and a to z.
3. Type the system password that you entered earlier in the **Confirm new password** field and press Enter.
4. Press **Yes** to save the changes.  
The computer restarts.

## Deleting or changing an existing system password or setup password

### Prerequisites

Ensure that the **Password Status** is Unlocked in the System Setup before attempting to delete or change the existing system password and/or setup password. You cannot delete or change an existing system password or setup password if the **Password Status** is Locked. To enter the System Setup, press F2 immediately after a power-on or reboot.

### Steps

1. In the **System BIOS** or **System Setup** screen, select **Passwords** and press Enter.  
The **System Security** screen is displayed.
2. In the **System Security** screen, verify that the **Password Status** is Unlocked.
3. Select **System Password**. Update or delete the existing system password, and press Enter.
4. Select **Setup Password**. Update or delete the existing setup password, and press Enter.  
 **NOTE:** If you change the system password and/or setup password, reenter the new password when prompted. If you delete the system password and/or setup password, confirm the deletion when prompted.
5. Press Esc. A message prompts you to save the changes.
6. Press Y to save the changes and exit from **System Setup**.  
The computer restarts.

# Clearing CMOS settings

## About this task

 **CAUTION:** Clearing CMOS settings reset the BIOS settings on your computer.

## Steps

1. Remove the [side cover](#).
2. Remove the [riser-card module](#).
3. Remove the [coin-cell battery](#).
4. Wait for one minute.
5. Replace the [coin-cell battery](#).
6. Replace the [riser-card module](#).
7. Replace the [side cover](#).

# Clearing system and setup passwords

## About this task

To clear the system or setup passwords, contact Dell technical support as described at [Contact Support](#).

 **NOTE:** For information about how to reset Windows or application passwords, see the documentation accompanying Windows or your application.

# Troubleshooting

## Dell SupportAssist Pre-boot System Performance Check diagnostics

### About this task

SupportAssist diagnostics (also known as system diagnostics) performs a complete check of your hardware. The Dell SupportAssist Pre-boot System Performance Check diagnostics is embedded within the BIOS and launched by the BIOS internally. The embedded system diagnostics provides options for particular devices or device groups allowing you to:

- Run tests automatically or in an interactive mode.
- Repeat the tests.
- Display or save test results.
- Run thorough tests to add more options and obtain details about any failed devices.
- View status messages that inform you when the tests are completed successfully.
- View error messages that inform you of problems encountered during testing.

 **NOTE:** Some tests for specific devices require user interaction. Always ensure that you are present at the computer when the diagnostic tests are performed.

For more information, see [How to Run Dell Preboot Diagnostics and Hardware Tests on Your Dell Computer](#).

## Running the SupportAssist Pre-Boot System Performance Check

### Steps

1. Turn on your computer.
2. As the computer boots, press the F12 key.
3. On the boot menu screen, select **Diagnostics**.  
The diagnostic quick test begins.

 **NOTE:** For more information about running the SupportAssist Pre-Boot System Performance Check on a specific device, see [Dell Support Site](#).

4. If there are any issues, error codes are displayed.  
Note the error code and validation number and contact Dell.

## Power-Supply Unit Built-in Self-Test

Built-in Self-Test (BIST) helps determine if the power-supply unit is working. To run self-test diagnostics on the power-supply unit of a desktop or all-in-one computer, search in the Knowledge Base Resource at [Dell Support Site](#).

## System-diagnostic lights

This section lists the system-diagnostic lights of your Dell Pro Max Micro FCM2250.

The following table shows different Service LED blinking patterns and associated problems. The diagnostic light codes consist of a two-digit number, and the digits are separated by a comma. The number stands for a blinking pattern; the first digit shows the number of blinks in amber color, and the second digit shows the number of blinks in white color. The Service LED blinks in the following manner:

- The Service LED blinks the number of times equal to the value of the first digit and turns off with a short pause.

- After that, the Service LED blinks the number of times equal to the value of the second digit.
- The Service LED turns off again with a longer pause.
- After the second pause, the blinking pattern will be repeated.

**Table 44. Diagnostic light codes**

Diagnostic light codes (Amber, White)	Problem description
1,1	TPM Detection Failure
1,2	Unrecoverable SPI Flash Failure
1,5	EC unable to program i-Fuse
1,6	Generic catch-all for ungraceful EC code flow errors
1,7	Non-RPMC Flash on Boot Guard fused system
1,8	Chipset "Catastrophic Error" signal has tripped
2,1	CPU configuration or CPU failure
2,2	System board: BIOS or Read-Only Memory (ROM) failure
2,3	No memory or Random-Access Memory (RAM) detected
2,4	Memory or Random-Access Memory (RAM) failure
2,5	Invalid memory installed
2,6	System board/Chipset Error
2,7	LCD failure SBIOS message
2,8	Display power-rail failure on the system board
3,1	CMOS battery failure
3,2	PCI of Video card/chip failure
3,3	Recovery image not found
3,4	Recovery image found but invalid
3,5	EC power-rail error
3,6	Flash corruption detected by SBIOS
3,7	Timeout waiting on ME to reply to HECI message
4,1	Memory DIMM power rail failure
4,2	CPU Power cable connection issue

## Recovering the operating system

When your computer is unable to boot to the operating system even after repeated attempts, it automatically starts Dell SupportAssist OS Recovery.

Dell SupportAssist OS Recovery is a stand-alone tool that is preinstalled on Dell computers running the Windows operating system. It consists of tools to diagnose and troubleshoot issues that may occur before your computer boots to the operating system. It enables you to diagnose hardware issues, repair your computer, back up your files, and restore your computer to its factory state.

You can also download it from the Dell Support website to troubleshoot and fix your computer when it fails to boot into the primary operating system due to software or hardware failures.

For more information about the Dell SupportAssist OS Recovery, see *Dell SupportAssist OS Recovery User's Guide* at [Serviceability Tools at the Dell Support Site](#). Click **SupportAssist** and then click **SupportAssist OS Recovery**.

 **NOTE:** Windows 11 IoT Enterprise LTSC 2024 and Dell ThinOS 10 do not support Dell SupportAssist. For more information about recovering ThinOS 10, see [Recovery mode using R-Key](#).

# Real-Time Clock—RTC reset

The Real-Time Clock (RTC) reset function allows you or the service technician to recover the recently launched model Dell Pro and Pro Max computers from **No POST/No Boot/No Power** situations. You can initiate the RTC reset on the computer from a power-off state only if it is connected to AC power. Press and hold the power button for 25 seconds. The system RTC reset occurs after you release the power button.

 **NOTE:** If AC power is disconnected from the computer during the process or the power button is held longer than 40 seconds, the RTC reset process gets aborted.

The RTC reset will reset the BIOS to its default settings, disable Intel vPro, and reset the computer date and time. The following items are not affected by the RTC reset:

- Service Tag
- Asset Tag
- Ownership Tag
- Admin Password
- System Password
- Storage Password
- Key Databases
- System Logs

 **NOTE:** The IT administrator's vPro account and password on the computer will be unprovisioned. The computer must go through the setup and configuration process again to reconnect it to the vPro server.

The below items may or may not be reset based on your custom BIOS setting selections:

- Boot List
- Enable Legacy Option ROMs
- Secure Boot Enable
- Allow BIOS Downgrade

## Backup media and recovery options

It is recommended to create a recovery drive to troubleshoot and fix problems that may occur with Windows. Dell provides multiple options for recovering the Windows operating system on your Dell computer. For more information, see [Dell Windows Backup Media and Recovery Options](#).

## Network power cycle

### About this task

If your computer is unable to access the Internet due to network connectivity issues, reset your network devices by performing the following steps:

### Steps

1. Turn off the computer.
2. Turn off the modem.

 **NOTE:** Some Internet service providers (ISPs) provide a modem and router combo device.

3. Turn off the wireless router.
4. Wait for 30 seconds.
5. Turn on the wireless router.
6. Turn on the modem.
7. Turn on the computer.



# Getting help and contacting Dell

## Self-help resources

You can get information and help on Dell products and services using these self-help resources:

**Table 45. Self-help resources**

Self-help resources	Resource location
Information about Dell products and services	<a href="#">Dell Site</a>
Tips	
Contact Support	In Windows search, type <code>Contact Support</code> , and press Enter.
Online help for operating system	<a href="#">Windows Support Site</a> <a href="#">Linux Support Site</a>
Access top solutions, diagnostics, drivers and downloads, and learn more about your computer through videos, manuals, and documents.	Your Dell computer is uniquely identified using a Service Tag or Express Service Code. To view relevant support resources for your Dell computer, enter the Service Tag or Express Service Code at <a href="#">Dell Support Site</a> .  For more information about how to find the Service Tag for your computer, see <a href="#">Locate the Service Tag on your computer</a> .
Dell knowledge base articles	<ol style="list-style-type: none"> <li>1. Go to <a href="#">Dell Support Site</a>.</li> <li>2. On the menu bar at the top of the Support page, select <b>Support &gt; Support Library</b>.</li> <li>3. In the Search field on the Support Library page, type the keyword, topic, or model number, and then click or tap the search icon to view the related articles.</li> </ol>

## Contacting Dell

To contact Dell for sales, technical support, or customer service issues, see [Contact Support at Dell Support Site](#).

 **NOTE:** Availability of the services may vary depending on the country or region, and product.

 **NOTE:** If you do not have an active Internet connection, you can find contact information in your purchase invoice, packing slip, bill, or Dell product catalog.

## Revision history

Tracks all updates that are made to the document. It typically includes the date of change, version number, and a brief description of the modification. This log helps maintain transparency, accountability, and a clear timeline of progress.

**Table 46. Revision history**

Revision	Date	Description
A00	03-2025	Original publish date.
A02	10-2025	<ul style="list-style-type: none"><li>• Updated audio section to include speaker information.</li><li>• Updated expansion slot information.</li><li>• Updated internal slot section</li><li>• Updated the maximum values for shock and vibration in the operating and storage environment topic.</li></ul>
A03	12-2025	Updated recommended tools to remove Torx #5 (T5) screwdriver